

HAND-BOOK OF STEEL SECTIONS

MANUFACTURED BY

DORMAN, LONG & COMPANY, LIMITED,

MIDDLESBOROUGH, ENGLAND.

STEEL SECTIONS,

MANUFACTURED BY

DORMAN, LONG, & CO., LIMITED,

MIDDLESBROUGH, ENGLAND.

~~~~~  
1895.  
~~~~~

London:

MCCORQUODALE & CO., LIMITED,
Carlington Street, N.W.

[ENTERED AT STATIONERS' HALL.]

INTRODUCTION TO SECTION BOOK.

For the convenience of Architects, Engineers, and Builders, this Book has been designed to show the different sections of Steel manufactured by Dorman, Long, & Co., Limited, at the Britannia Steel Works, Middlesbrough. All our Steel is manufactured by the "Siemens-Martin Open Hearth Acid Process," which is recognised by engineers and architects as being the most reliable process for the production of Steel of a high-class uniform quality. The tests we guarantee are as follows:—28 to 32 tons tensile strain per square inch; 20 per cent. elongation in a length of 8 inches.

The above-named tests are accepted by the Admiralty and Lloyd's Inspectors.

A speciality is made of Steel Joists, now so largely used in constructional work, and in the following pages tables will be found giving full particulars of the moments of inertia and resistance of these sections, and the safe loads that these joists will carry, for varying spans, have been carefully worked out.

* **Note.**—Three different factors of safety are shown—viz., *a*, *b*, and *c*, representing respectively 10·6, 8, and 6·4 tons tensional strain per square inch of section, which is practically $\frac{1}{3}$ rd, $\frac{1}{4}$ th, and $\frac{1}{5}$ th of the breaking strain.

Table *a* may be used for carrying permanent dead loads not liable to variation; Table *b* for ordinary live loads applied gradually; and Table *c* for live loads rapidly applied, and for machinery in motion.

In planning a floor, the first thing to be determined is the load that will be placed upon it. This consists of the weight of the materials composing the floor—or the dead load—and the

weight of the persons or goods—being the live load, which together make up the total load. The dead load of a fire-proof floor made of steel joists and 6 in. coke-breeze concrete may be taken at 70 lbs. per square foot, and the live load for dwellings or offices may be put down at 84 lbs. additional, giving a total load of 154 lbs. In public buildings or schools, where large numbers of persons in motion may congregate, or in warehouses where heavy goods are stored, the total loads to be provided for will be of greater weight. The following may therefore be taken as being approximately safe total loads per square foot, for ordinary sections :—

	Lbs.
Dwellings or Office Buildings	150
Public Halls or Schools.	180
Warehouses	200 to 400
Heavy Machinery	300 to 500

In selecting joists, the proportion of depth to length should not be less than 1-20th of the span ; otherwise, deflection may take place. Due allowance must be made for all holes drilled in the joists for connections, &c., most especially for such that are placed in the flanges. When one joist alone is insufficient to carry a specified load, a convenient method may be adopted by using cast-iron distance pieces and bolts, as sketch on page 142. These are specially useful for lintels.

A most convenient form for small girders is made in the adoption of joists in combination with flange plates, and also with channels with flange plates. Various examples of these are shown in this book, and tables of the carrying powers of these girders are given similar to those of the joists. Should any of the compounds be of insufficient strength, the plates may be made thicker or wider to suit the circumstances.

Examples are also given of Plate and Box Girders, built up of angles and plates, &c., the

tables of strengths for which are calculated at 7.5 tons per square in. of sectional area contained in the flanges. These girders are suitable for carrying dead or ordinary live loads.

NOTES ON STANDARD ANGLE CONNECTIONS FOR JOISTS.

Standard Angle Cleats for all sections of Steel Joists are illustrated on pages 89, 90, and 91.

These connections have been designed in proportion to the different sizes of joists used in ordinary practice, and having the usual relations of depth of beam to length of span. In extreme cases, where beams of short spans in proportion to the depth are loaded to their full capacity, it will be found necessary to increase the strength of these connections.

Standard Joint Plates for Girders are shown on page 92.

Standard Spacings for position of holes which may be required in the flange of the joists are given for every size, and this should be adhered to wherever practicable. Sketches are also given on page 140 of the different methods of forming connections; and for facility in ordering, reference letters are given, so that the exact description of joint selected may be supplied.

STANCHEONS.

On page 144 a table is given of the carrying load of Joists used as Stancheons. Where these are not strong enough, Compound Stancheons, as shown on page 143, could be used to carry any desired weight.

LIMITING DIMENSIONS OF STEEL SECTIONS.

The following is a list of the lengths to which bars can be rolled without extra:—

ORDINARY.	Flat Bars.	Round and Square.	Angle.	Tee	Channel and Joist.
Length, feet	40	24	50	50	36
Width, inches	18	4 squares 8 rounds	6 × 6	5 × 3	12
Thickness, inches ..	1	..	$\frac{7}{8}$	$\frac{3}{8}$..
MAXIMUM.					
Length, feet	60	60	60	60	50
Width, inches	18	4 squares 8 rounds	8 × 8	6 × 3	20 × $7\frac{1}{2}$
Thickness, inches ..	1	4	1	$\frac{1}{2}$	$\frac{5}{8}$

An extra is charged on Maximum Lengths.

The Thickness of Angles may be increased within certain limits.

The Thickness of Tees can be varied as shown.

Channel Bars may be rolled thicker in the web, but the flanges cannot be altered.

Zed Bars.—The thickness of web can be increased within limits shown, $\frac{1}{16}$ in. to $\frac{1}{4}$ in., on diagrams.

Bulb Tees and Bulb Angles can be cambered to any sweep, and kneed to any requirements.

The Weights of Joists, Compounds, &c., &c., are calculated at “per foot,” except in the case of Rails, which are given at “per yard.” The customary margin to be allowed in rolling is $2\frac{1}{2}$ per cent. over or under the specified weights, and we cannot guarantee to roll sections without this allowance.

Angle of Flange of Joists.—The taper of the flange of the Joists is rolled to an angle of 98° with the web.

Stock Joists and Rolling orders are cut while hot to a margin of 1 in. over or under specified lengths. An extra is charged for cutting to exact lengths varying $\frac{1}{8}$ in., and for facing square.

Unless otherwise specified, all the holes in girders and for connections will be punched; an extra is charged for drilled work.

Large stocks of Joists, amounting to nearly 5,000 tons, are kept at our works, Middlesbrough, and 3,000 tons are kept at our London stockyard. Small quantities of the other sections we roll are also kept in stock at both places. The necessary plates for making up compounds are also kept, and these girders can be supplied from Middlesbrough or London stock at the shortest notice.

All Joists are kept in stock in London and Middlesbrough in even feet, but can be cut to any length at the cost of cutting and waste. The Joists marked * are those most frequently used, and of which we keep the largest stock.

All our Joists, Angles, &c., have our name rolled upon them, and engineers and architects are invited to inspect Joists specified to be of our manufacture, to see that our name is rolled thereon.

Prices, terms, and any further information can be obtained on application.

GENERAL FORMULÆ EXPLANATORY OF THE TABLES AND THEIR APPLICATION.

A = Area of section in square inches.

L = Length of span in feet.

l = Length of span in inches.

w = Distributed load in tons that one foot will carry.

W = Load in tons on the whole span, uniformly distributed.

K = Coefficient of safety = 10.6, 8.0, and 6.4 tons (see note * in text).

Co = Constant proportion of one manner of load to another, the base 1 being equal to a cantilever loaded at one end (see note, page 47).

n = Distance of centre of gravity of section, from top or bottom, in inches.

R = Moment of resistance in square inches.

I = Vertical, or greatest moment of inertia.

J = Horizontal, or least moment of inertia.

E = Modulus of elasticity = 12,000 tons for our steel.

C = Modulus of rupture = 28 to 32 tons per square inch.

D = Deflection of girder under its full load.

$$\text{Then } R = \frac{I}{n}$$

$$W = \frac{w}{L}$$

$$D = \frac{5 W l^3}{384 E I} \text{ for beam supported at both ends and uniformly loaded.}$$

$$D = \frac{P l^3}{48 E I} \text{ for beam supported at both ends and loaded with a single load } P \text{ at centre of span.}$$

$$D = \frac{W l^3}{8 E I} \text{ for beam fixed at one end and unsupported at the other, and uniformly loaded.}$$

$$D = \frac{P l^3}{3 E I} \text{ for beam fixed at one end and unsupported at the other, and loaded with a single load } P \text{ at the latter end.}$$

DORMAN, LONG & COMPANY, LIMITED, MIDDLESBOROUGH.

Sizes of Steel Bars.

All dimensions given are in inches.

ROUNDS.

$\frac{3}{4}$, $\frac{7}{8}$, 1, $1\frac{1}{8}$, $1\frac{1}{4}$, $1\frac{3}{8}$, $1\frac{1}{2}$, $1\frac{5}{8}$, $1\frac{3}{4}$, $1\frac{7}{8}$, 2, $2\frac{1}{8}$, $2\frac{1}{4}$, $2\frac{3}{8}$, $2\frac{1}{2}$,
 $2\frac{5}{8}$, $2\frac{3}{4}$, $2\frac{7}{8}$, 3, $3\frac{1}{8}$, $3\frac{1}{4}$, $3\frac{3}{8}$, $3\frac{1}{2}$, $3\frac{5}{8}$, $3\frac{3}{4}$, $3\frac{7}{8}$, 4.

and rising by $\frac{1}{4}$ " to 8'.

SQUARES.

$\frac{3}{4}$, $\frac{7}{8}$, 1, $1\frac{1}{8}$, $1\frac{1}{4}$, $1\frac{3}{8}$, $1\frac{1}{2}$, $1\frac{5}{8}$, $1\frac{3}{4}$, $1\frac{7}{8}$, 2, $2\frac{1}{8}$, $2\frac{1}{4}$, $2\frac{3}{8}$, $2\frac{1}{2}$,
 $2\frac{5}{8}$, $2\frac{3}{4}$, $2\frac{7}{8}$, 3, $3\frac{1}{8}$, $3\frac{1}{4}$, $3\frac{3}{8}$, $3\frac{1}{2}$, $3\frac{5}{8}$, $3\frac{3}{4}$, $3\frac{7}{8}$, 4.

FLATS.

Width	Thickness	Width	Thickness	Width	Thickness	Width	Thickness
$1\frac{1}{2}$	$\frac{1}{4}$ to 1	3	$\frac{1}{4}$ to 1	5	$\frac{5}{16}$ to 1	10	$\frac{3}{8}$ to 1
$1\frac{3}{4}$	" " "	$3\frac{1}{4}$	" " "	$5\frac{1}{2}$	" " "	11	" " "
2	" " "	$3\frac{1}{2}$	" " "	6	" " "	12	" " "
$2\frac{1}{4}$	" " "	$3\frac{3}{4}$	" " "	7	$\frac{3}{8}$ to 1	14	$\frac{1}{2}$ to 1
$2\frac{1}{2}$	" " "	4	" " "	8	" " "	15	" " "
$2\frac{3}{4}$	" " "	$4\frac{1}{2}$	$\frac{5}{16}$ to 1	9	" " "	16	" " "
						18	$\frac{1}{2}$ to 1

DORMAN, LONG & COMPANY, LIMITED, MIDDLESBOROUGH.

EQUAL ANGLES.

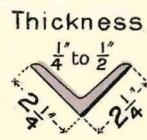
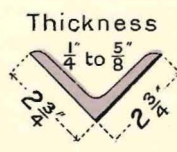
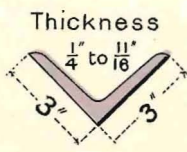
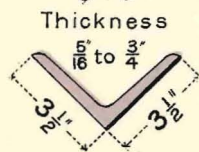
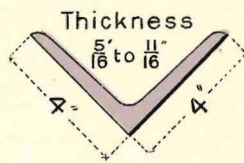
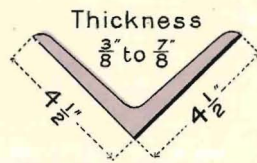
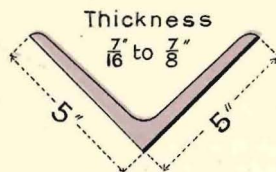
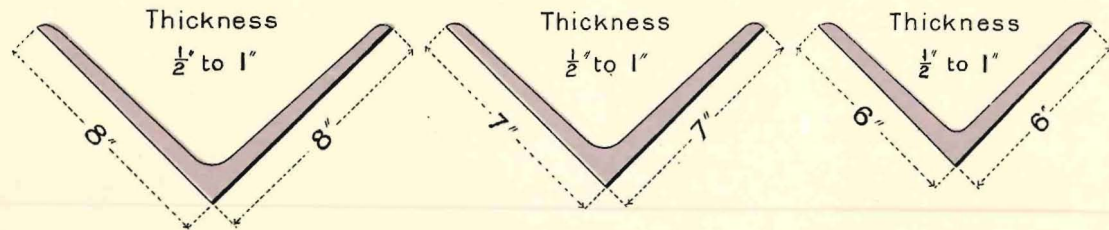

DORMAN, LONG & COMPANY, LIMITED, MIDDLESBOROUGH.

EQUAL ANGLES.



DORMAN, LONG & COMPANY, LIMITED, MIDDLESBOROUGH.

UNEQUAL ANGLES.

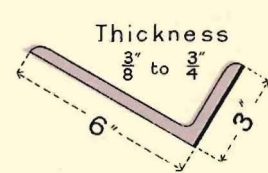
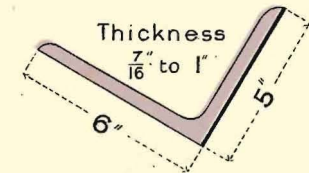
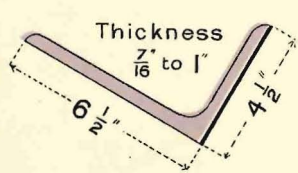
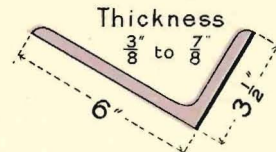
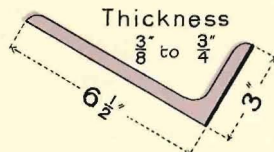
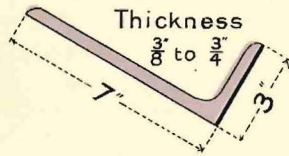
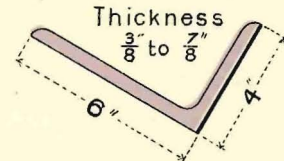
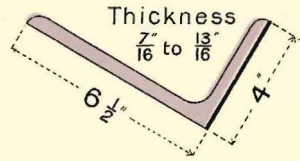
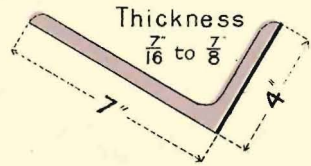

DORMAN, LONG & COMPANY, LIMITED, MIDDLESBOROUGH.

UNEQUAL ANGLES.

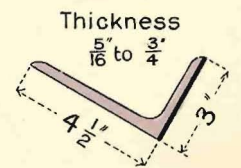
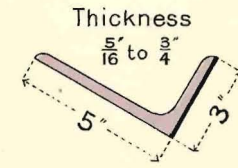
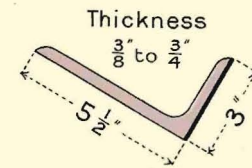
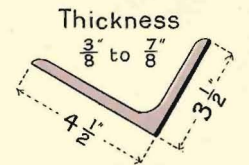
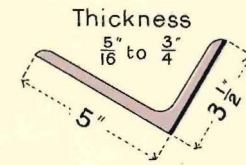
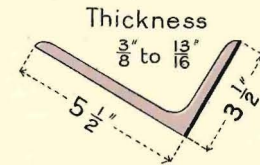
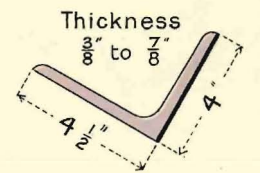
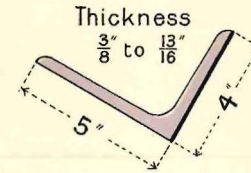
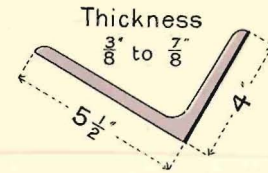

DORMAN, LONG & COMPANY, LIMITED, MIDDLESBOROUGH.

UNEQUAL ANGLES.

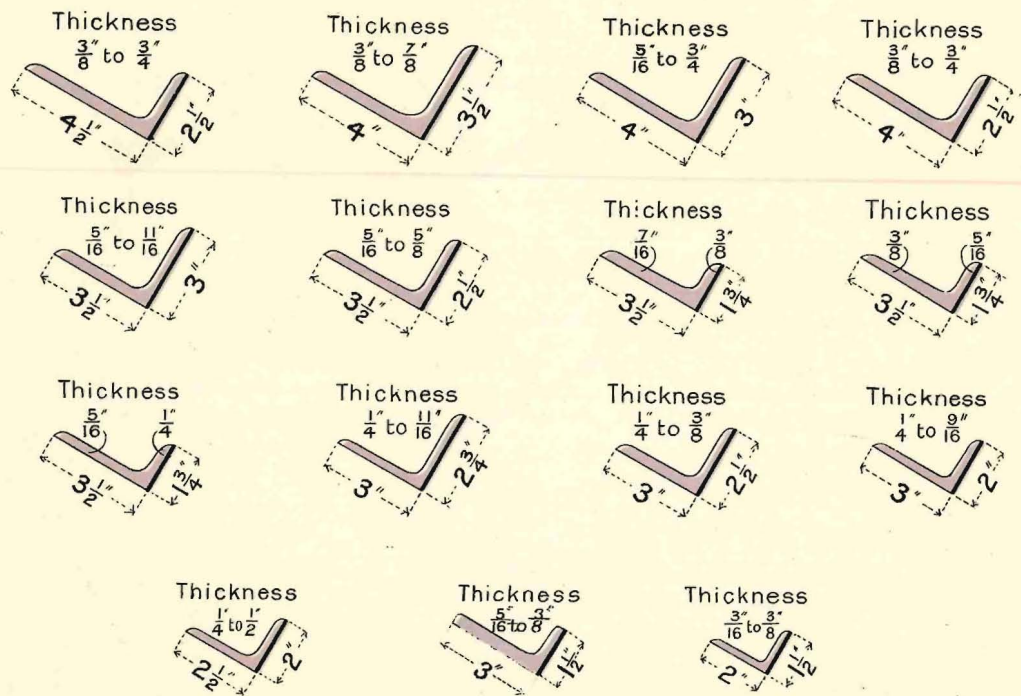

DORMAN, LONG & COMPANY, LIMITED, MIDDLESBOROUGH.

Hollow & Solid Half Rounds.

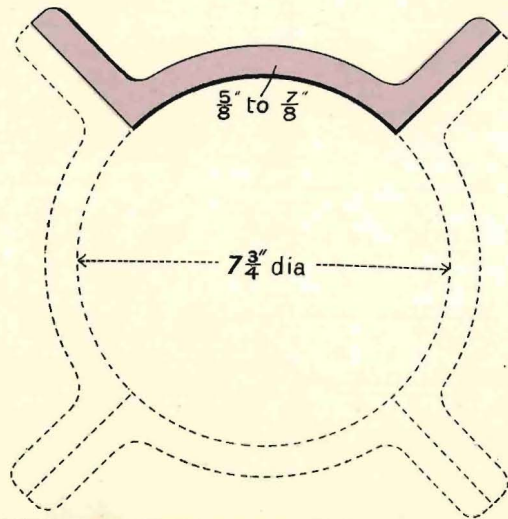
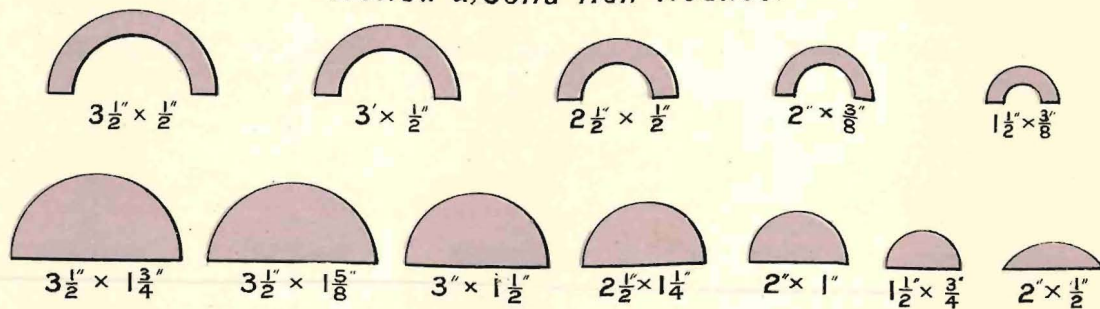

PILLAR SECTIONS.

Inside Diameter	Thickness
$7\frac{3}{4}$ "	$\frac{5}{16}$ to $\frac{7}{8}$ "
$7\frac{1}{2}$ "	$\frac{3}{16}$ " " $\frac{5}{8}$ "
$6\frac{3}{4}$ "	$\frac{3}{16}$ " " $\frac{7}{8}$ "
6"	$\frac{1}{8}$ " " $\frac{3}{4}$ "

NOTE.

Rolls will be turned for any of these sizes of Pillars, on a sufficient quantity being ordered.

DORMAN, LONG & COMPANY, LIMITED, MIDDLESBOROUGH.

TEES.

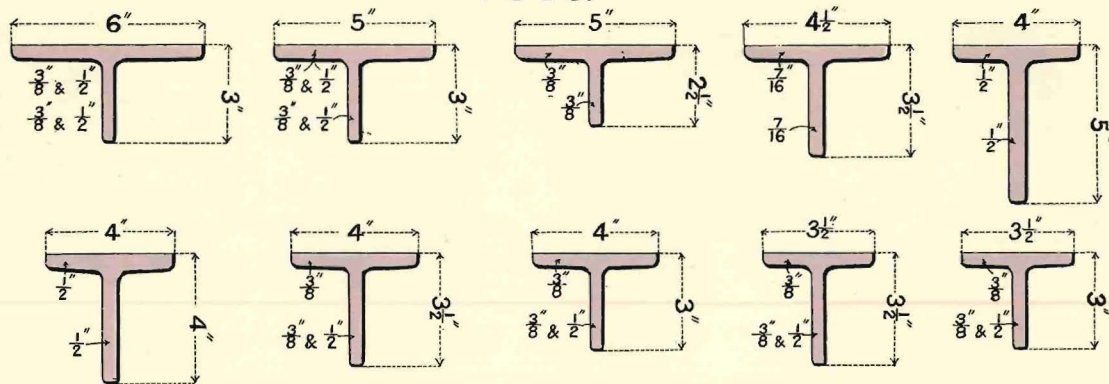

TABLE FOR STOCK SECTIONS.

NORMAL SIZES IN INCHES FLANGE BY STEM.	WEIGHT PER FOOT IN LBS.	THICKNESS OF FLANGE IN INCHES.	THICKNESS OF STEM IN INCHES	AREA IN SQUARE INCHES	VERTICAL OR GREATEST MOMENTS OF INERTIA
6 x 3	10.97	.375	.375	3.23	2.13
5 x 3	9.69	.375	.375	2.85	2.04
5 x 2 1/2	9.08	.375	.375	2.67	1.20
4 1/2 x 3 1/2	11.25	.4375	.4375	3.31	3.52
4 x 5	14.45	.5	.5	4.25	10.461
4 x 4	12.75	.5	.5	3.75	5.56
4 x 3 1/2	9.15	.375	.375	2.67	2.97
4 x 3	8.43	.375	.375	2.48	1.91
3 1/2 x 3 1/2	8.43	.375	.375	2.48	2.87
3 1/2 x 3	7.78	.375	.375	2.29	1.84

DORMAN, LONG & COMPANY, LIMITED, MIDDLESBOROUGH.

TEES

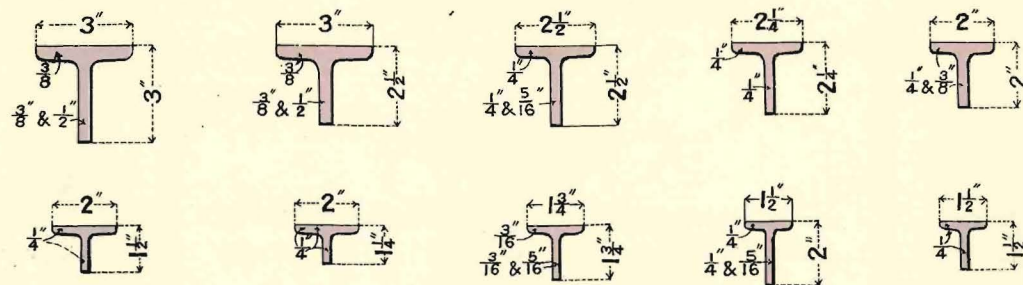
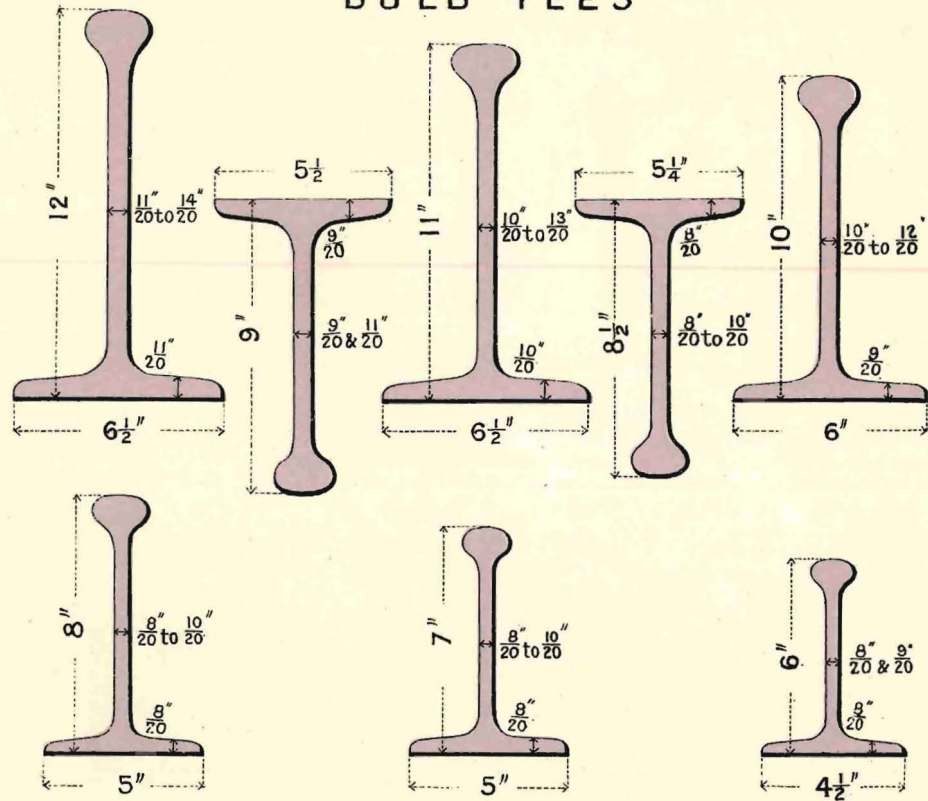

TABLE FOR STOCK SECTIONS.

NORMAL SIZES IN INCHES FLANGE BY STEM.	WEIGHT PER FOOT IN LBS.	THICKNESS OF FLANGE IN INCHES.	THICKNESS OF STEM IN INCHES	AREA IN SQUARE INCHES	VERTICAL OR GREATEST MOMENTS OF INERTIA
3 x 3	7.17	.375	.375	2.11	1.76
3 x 2 1/2	6.46	.375	.375	1.92	1.04
2 1/2 x 2 1/2	4.05	.25	.25	1.19	.704
2 1/4 x 2 1/4	3.61	.25	.25	1.06	.504
2 x 2	3.18	.25	.25	.94	.347
2 x 1 1/2	2.76	.25	.25	.81	.151
1 3/4 x 1 3/4	2.11	.1875	.1875	.621	.179
1 1/2 x 2	2.76	.25	.25	.81	.315
1 1/2 x 1 1/2	2.33	.25	.25	.687	.138

DORMAN, LONG & COMPANY, LIMITED, MIDDLESBOROUGH.

BULB TEES



DORMAN, LONG & COMPANY, LIMITED, MIDDLESBOROUGH.

BULB BARS

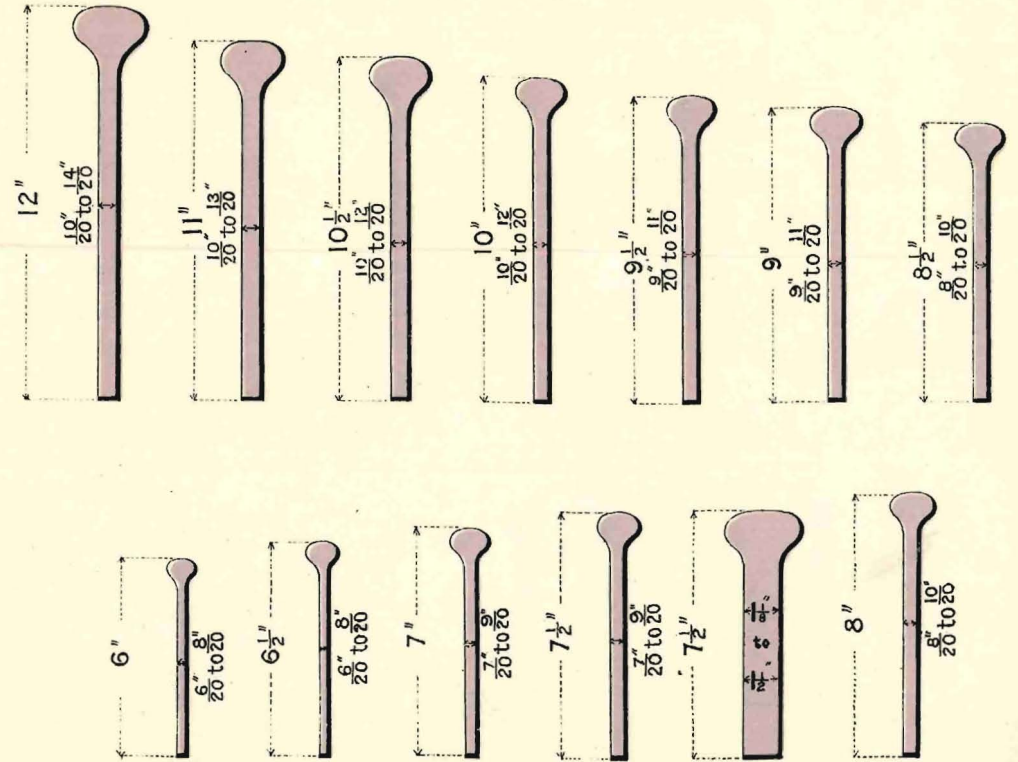

DORMAN, LONG & COMPANY, LIMITED, MIDDLESBOROUGH.

BULB TEE DECK BEAMS

CAMBERED AND KNEED TO SUIT ANY FORM OF VESSEL

Nº 1

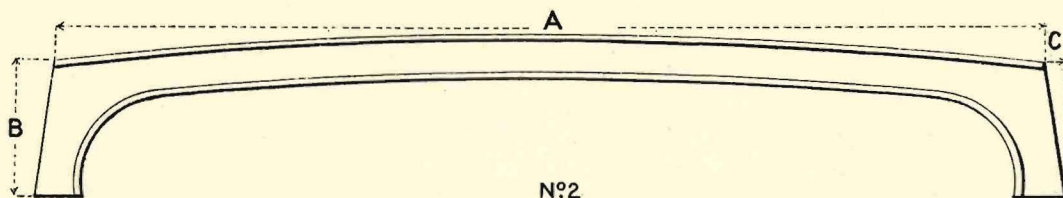

Nº 2

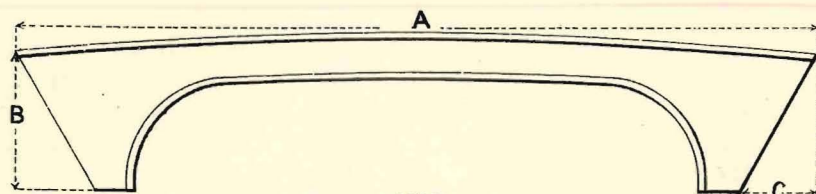

Nº 3

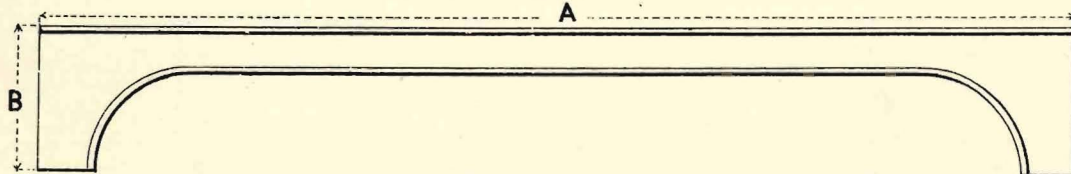

When enquiring prices or ordering please give reference Number and dimensions as per Letters A.B.C. With Orders. Cambering and Kneeing Boards must be forwarded in all Cases.

DORMAN, LONG & COMPANY, LIMITED, MIDDLESBOROUGH.

Hatchway Sections.

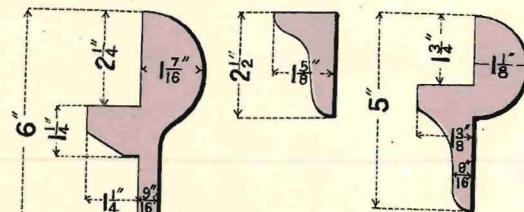

Jack Stay.

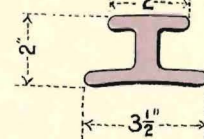

Gluts

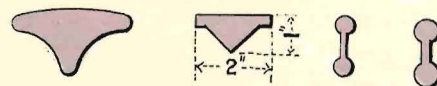

Special Bulb Tee.

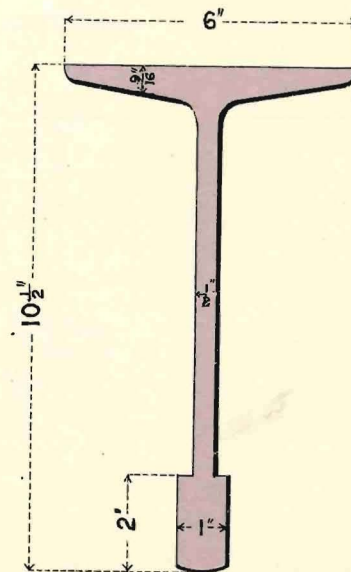

DORMAN, LONG & COMPANY, LIMITED, MIDDLESBOROUGH.

RAILS

N.B. Weights of all rails are "per yard."

Fishplates to suit these sections.

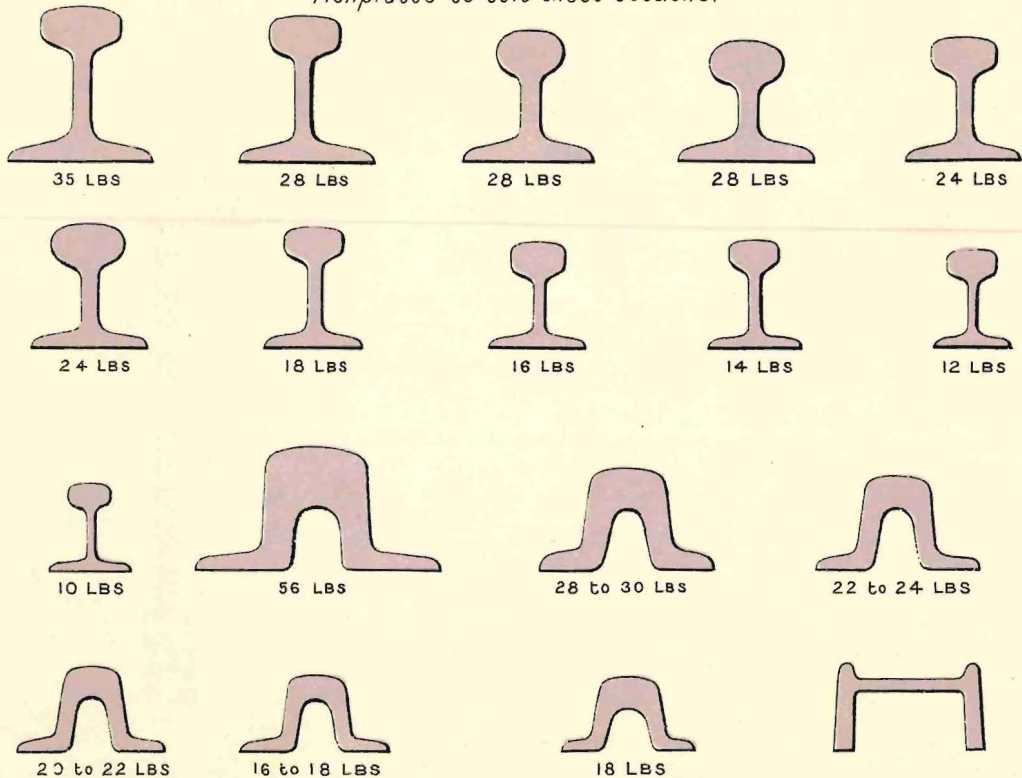
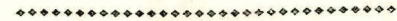

TABLE OF JOISTS, GIVING THE WEIGHTS, SIZES, MOMENTS OF RESISTANCE AND INERTIA, AND LOADS THAT ONE FOOT WILL CARRY.



The joists marked * are those most frequently used, and of which we keep the largest stock.

DEPTH OF GIRDERS should not be less than $\frac{1}{20}$ th of the span.

For safe distributed loads on any girder, divide figures in Table by clear span required in feet.

NOTE. {The figures in Red denote our stock, or general sections, and those in Black are sections we roll under special agreement.

Plate.	Number of Section.	Weight per Foot in Lbs.	Normal Sizes in Inches.	Dimensions in Inches.		Web Thick-ness.	Mean Th. of Flange.	Square Inches Area.	Moments of Resist-ance in Square Inches.	Vertical or Greatest Moments of Inertia.	Hori-zontal or Least Moments of Inertia.	Distributed Loads in Tons that One Foot will carry.			
				Depth.	Width.							Coefficients of Stress. (See page 1.)			
												a.	b.	c.	
56	G1 +	92	20 x 7 $\frac{1}{2}$	20 x 7.56	.66	1.0	27.22								
	*G1 G1 -	89 88	„ x „ „ x „	„ x 7.5 „ x 7.48	.6 .58	„ „	26.2 25.9	164.66	1646.6	70.63	1170.91	878.18	702.54		
57	G2 +	82	18 x 7	18 x 7.11	.66	.94	24.12								
	*G2 G2 -	75 74	„ x „ „ x „	„ x 7 „ x 6.98	.55 .53	„ „	22.06 21.7	127.83	1150.53	53.95	909.06	681.8	545.43		
58	G3 +	66	16 x 6	16 x 6.07	.63	.85	19.4								
	*G3 G3 -	62 60	„ x „ „ x „	„ x 6 „ x 5.96	.56 .52	„ „	18.23 17.64	90.29	722.36	30.80	642.09	481.57	385.25		

Plate.	Number of Section.	Weight per Foot in Lbs.	Normal Sizes in Inches.	Dimensions in Inches.			Square Inches Area.	Moments of Resistance in Square Inches.	Vertical or Greatest Moments of Inertia.	Horizontal or Least Moments of Inertia.	Distributed Loads in Tons that One Foot will carry.			
				Depth.	Width.	Web Thick-ness.					Mean Th. of Flange.	Coefficients of Stress. (See page 1.)		
												a.	b.	c.
87	G31 +	7	3½ × 1½	3½ × 1.582	.378	.3	2.05							
	*G31 G31 -	6 5	„ × „ „ × „	„ × 1.5 „ × 1.414	.296 .21	„ „	1.76 1.46	1.66	2.91	.17	11.82	8.86	7.09	
87	G32 +	12	3 × 3	3 × 3.196	.486	.38	3.52							
	*G32 G32 -	10 9	„ × „ „ × „	„ × 3 „ × 2.903	.29 .193	„ „	2.93 2.64	2.8	4.21	1.71	19.95	14.96	11.97	
87	G33 +	5	3 × 1½	3 × 1.346	.314	.25	1.46							
	*G33 G33 -	4 3.5	„ × „ „ × „	„ × 1.25 „ × 1.192	.218 .168	„ „	1.17 1.02	.98	1.47	.08	6.96	5.22	4.18	

NEW SECTIONS.

65	G7 ^b +	46	12 × 6										
	*G7 ^b G7 ^b -	44	„ × „ „ × „	12 × 6	.41	.72	12.9	52.4	314.4	25.9	372.6	279.5	223.6
85	G28 ^a +	10.5	4 × 3	4 × 3.075	.3	.34	3.09						
	*G28 ^a G28 ^a -	9.5 9	„ × „ „ × „	„ × 3 „ × 2.937	.225 .185	„ „	2.79 2.64	3.769	7.538	1.53	26.8	20.1	16.06
62	G11 ^b	21.5	9½ × 3¾	9.25 × 3.75	.36	.438	6.45	17.52	81.0	3.88	124.54	93.40	74.72
72	G6 ^c	82	14 × 6	14 × 6	1.0	1.0	Special Section for Piles.						

The joists marked * are those most frequently used, and of which we keep the largest stock.

TABLES OF SAFE DISTRIBUTED LOADS IN TONS, ON JOISTS OF VARYING SPANS.

Plate.	Normal Sizes in Inches.	Weight per Foot in Lbs.	Safe Coefficient. (See page 1.)	Clear Spans in Feet between Supports.																					
				10'	12'	14'	16'	18'	20'	22'	24'	26'	28'	30'	32'										
				56	*20 × 7½	89	a b c			83	73	65	58	53	48	45	41	39	36						
		62	54					48	43	39	36	33	31	29	27	25	23	21							
		50	43					39	35	31	29	27	25	23	21	19	18	16							
57	*18 × 7	75	a b c			64	56	50	45	41	37	34	32	30	28	26	24	22							
						48	42	37	34	30	28	26	24	22	21	19	18	16							
						39	34	30	27	24	22	21	19	18	16	14	13	11	10						
58	*16 × 6	62	a b c		53	45	40	35	32	29	26	24	22	20	18	17	15	13							
					40	34	30	26	24	21	20	18	17	16	14	13	11	10							
					32	27	24	21	19	17	16	14	13	11	10	9	8	7	6	5					
59	16 × 5	50	a b c		41	35	30	27	24	22	20	19	17	16	14	13	11	10							
					30	26	23	20	18	16	15	14	13	12	11	10	9	8	7	6					
					24	21	18	16	14	13	12	11	10	9	8	7	6	5	4	3	2				
60	*15 × 6	59	a b c		58	48	41	36	32	29	26	24	22	20	18	16	14	13							
					43	36	31	27	24	21	19	18	16	14	13	11	10	9	8	7	6				
					35	29	25	22	19	17	16	14	13	11	10	9	8	7	6	5	4	3			
61	*15 × 5	42	a b c		39	32	28	24	21	19	17	16	15	14	13	11	10	9	8	7	6				
					29	24	21	18	16	14	13	12	11	10	9	8	7	6	5	4	3	2	1		
					23	19	16	14	13	11	10	9	8	7	6	5	4	3	2	1	0	0	0	0	
62	*14 × 6	57	a b c		52	44	37	33	29	26	24	22	20	18	16	14	13	11	10	9	8	7	6		
					39	33	28	24	22	19	18	16	14	13	12	11	10	9	8	7	6	5	4	3	
					31	26	22	19	17	15	14	13	12	11	10	9	8	7	6	5	4	3	2	1	0
63	14 × 6	46	a b c		42	35	30	26	23	21	19	18	16	14	13	12	11	10	9	8	7	6	5		
					32	26	22	20	17	16	14	13	12	11	10	9	8	7	6	5	4	3	2	1	
					25	21	18	16	14	12	11	10	9	8	7	6	5	4	3	2	1	0	0	0	0
64	13 × 5	41½	a b c		32	27	23	20	18	16	14	13	12	11	10	9	8	7	6	5	4	3	2		
					24	20	17	15	13	12	11	10	9	8	7	6	5	4	3	2	1	0	0	0	0
					19	16	14	12	10	9	8	7	6	5	4	3	2	1	0	0	0	0	0	0	0
65	*12 × 6	54	a b c		43	36	31	27	24	21	19	18	16	14	13	12	11	10	9	8	7	6	5		
					32	27	23	20	18	16	14	13	12	11	10	9	8	7	6	5	4	3	2	1	0
					26	22	18	16	14	13	12	11	10	9	8	7	6	5	4	3	2	1	0	0	0

Loads in Tons.

Plate.	Normal Sizes in Inches.	Weight per Foot in Lbs.	Safe Coefficient. (See page 1.)	Clear Spans in Feet between Supports.							
				8'	10'	12'	14'	16'	18'	20'	
65	*12×6	44	<i>a</i>		37	31	26	23	20	18	Loads in Tons.
			<i>b</i>		27	23	20	17	15	14	
			<i>c</i>		22	18	16	14	12	11	
66	12×5	32	<i>a</i>		26	21	18	16	14	13	
			<i>b</i>		19	16	14	12	10	9	
			<i>c</i>		15	13	11	9	8	7	
67	*12×5	39	<i>a</i>		30	25	21	18	16	15	
			<i>b</i>		22	18	16	14	12	11	
			<i>c</i>		18	15	12	11	10	9	
68	*10×6	45	<i>a</i>	38	30	25	22	19			
			<i>b</i>	28	23	19	16	14			
			<i>c</i>	23	18	15	13	11			
69	*10×5	35	<i>a</i>	28	22	19	16	14			
			<i>b</i>	21	17	14	12	10			
			<i>c</i>	17	13	11	9	8			
70	*10×5	29	<i>a</i>	25	20	16	14	12			
			<i>b</i>	19	15	12	10	9			
			<i>c</i>	15	12	10	8	7			
71	10×4½	30	<i>a</i>	25	20	16	14	12			
			<i>b</i>	18	15	12	10	9			
			<i>c</i>	15	12	10	8	7			
72	9½×4½	36	<i>a</i>	28	22	18	16	14			
			<i>b</i>	21	16	14	12	10			
			<i>c</i>	16	13	11	9	8			
73	*9×7	58	<i>a</i>	42	34	28	24	21			
			<i>b</i>	32	25	21	18	16			
			<i>c</i>	25	20	17	14	12			
74	*9×3¾	20	<i>a</i>	14	11	9	8	7			
			<i>b</i>	11	8	7	6	5			
			<i>c</i>	9	7	6	5	4			

Plate.	Normal Sizes in Inches.	Weight per Foot in Lbs.	Safe Coefficient. (See page 1.)	Clear Spans in Feet between Supports.						
				4'	6'	8'	10'	12'	14'	
75	*8×6	35	<i>a</i>		33	24	19	16	14	Loads in Tons.
			<i>b</i>		24	18	14	12	10	
			<i>c</i>		19	14	11	9	8	
75	8×5	30	<i>a</i>		27	20	16	13	11	
			<i>b</i>		20	15	12	10	9	
			<i>c</i>		16	12	10	8	7	
76	8×4	25	<i>a</i>		21	16	13	10	9	
			<i>b</i>		16	12	9	8	7	
			<i>c</i>		13	9	7	6	5	
76	*3×4	19	<i>a</i>		16	12	10	8	7	
			<i>b</i>		12	9	7	6	5	
			<i>c</i>		10	7	6	5	4	
77	*7×3¾	18	<i>a</i>	21	14	10	8	7		
			<i>b</i>	15	10	7	6	5		
			<i>c</i>	12	8	6	5	4		
88	7×3¾	16	<i>a</i>	18	12	9	7	6		
			<i>b</i>	13	9	6	5	4		
			<i>c</i>	10	7	5	4	3		
77	6½×3½	18	<i>a</i>	18	12	9	7			
			<i>b</i>	14	9	7	5			
			<i>c</i>	11	7	5	4			
78	*6×5	25	<i>a</i>	25	17	12	10			
			<i>b</i>	19	13	9	7			
			<i>c</i>	15	10	7	6			
78	6×4½	20	<i>a</i>	19	13	10	8			
			<i>b</i>	14	9	7	5			
			<i>c</i>	11	7	5	4			
79	6×3	16	<i>a</i>	14	9	7	5			
			<i>b</i>	11	7	5	4			
			<i>c</i>	8	5	4	3			

Plate.	Normal Sizes in Inches.	Weight per Foot in Lbs.	Safe Coefficient. (See page 1.)	Clear Spans in Feet between Supports.			
				4'	6'	8'	10'
79	6 × 3	13	a	12	8	6	4
			b	9	6	4	3
			c	7	4	3	2
80	6 × 2	12	a	9	6	4	3
			b	7	4	3	2
			c	5	3	2	2
80	5½ × 2	10½	a	8	5	4	3
			b	6	4	3	2
			c	5	3	2	2
81	5¼ × 1½	9	a	6	4	3	
			b	4	3	2	
			c	3	2	1	
81	*5 × 5	24	a	21	14	10	
			b	15	10	7	
			c	12	8	6	
82	5 × 4½	22	a	19	12	9	
			b	14	9	7	
			c	11	7	5	
82	*5 × 4¾	19	a	15	10	7	
			b	11	7	5	
			c	9	6	4	
83	5 × 3	15	a	11	7	5	
			b	8	5	4	
			c	6	4	3	
83	*5 × 3	11	a	9	6	4	
			b	7	4	3	
			c	6	3	2	
84	4¾ × 1¾	10	a	6	4	3	
			b	4	3	2	
			c	3	2	2	

Loads in Tons.

Plate.	Normal Size in Inches.	Weight per Foot in Lbs.	Safe Coefficient. (See page 1.)	Clear Spans in Feet between Supports.			
				2'	4'	6'	8'
84	*4¾ × 1¾	6½	a		4	3	2
			b		3	2	1
			c		2	1	1
85	4½ × 3	14	a		10	6	5
			b		7	5	3
			c		6	4	3
85	4 × 3	12	a	16	8	5	
			b	12	6	4	
			c	9	4	3	
85	*4 × 3	9½	a	13	6	4	
			b	10	5	3	
			c	8	4	2	
86	*4 × 1¾	8	a	9	4	3	
			b	6	3	2	
			c	5	2	1	
88	4 × 1¾	5	a	6	3	2	
			b	4	2	1	
			c	3	1	1	
86	3½ × 3	10½	a	11	5	3	
			b	8	4	2	
			c	7	3	2	
87	*3½ × 1½	6	a	6	3	2	
			b	4	2	1	
			c	3	1	1	
87	*3 × 3	10	a	10	5		
			b	7	3		
			c	6	3		
87	*3 × 1¾	4	a	3	1		
			b	2	1		
			c	2	1		

Loads in Tons.

JOIST COMPOUND GIRDERS.

NOTE.

These Compound Girders are made up from our "Mean" or "Stock" sections. These Compounds are not kept in stock, but can be supplied on the Shortest Notice. The Weights per foot are approximate only.

Plate.	Number of Section.	Weight per Foot in Lbs.	Sizes in Inches.	Compound of	Area in Square Inches.	Moments of Resistance in Square Inches.	Vertical or Greatest Moments of Inertia.	Distributed Load in Tons that One Foot will carry. (See page 1.)	
								b.	c.
93	G1 C1	144	21¼ × 12	1 G1 and 2-⅝ in. plates	37.95	287.51	3054.88	1533.48	1226.72
94	G1 C2	260	21¼ × 18	2 G1 " 2-⅝ "	68.4	497.69	5287.98	2654.86	2123.48
95	G1 C3	377	21¼ × 24	3 G1 " 2-⅝ "	98.85	707.86	7521.08	3775.29	3020.28
96	G1 C4	195	22½ × 12	1 G1 " 4-⅝ "	51.7	437.85	4925.83	2335.51	1868.4
97	G1 C5	335	22½ × 18	2 G1 " 4-⅝ "	88.4	716.43	8059.9	3821.02	3056.81
98	G1 C6	480	22½ × 24	3 G1 " 4-⅝ "	125.1	994.97	11193.48	5306.54	4245.23
99	G1 C7	248	23¾ × 12	1 G1 " 6-⅝ "	65.45	596.89	7088.1	3183.48	2546.74
100	G1 C8	414	23¾ × 18	2 G1 " 6-⅝ "	108.4	947.58	11252.51	5054.36	4043.48
101	G1 C9	582	23¾ × 24	3 G1 " 6-⅝ "	151.35	1298.49	15419.59	6925.29	5540.23
102	G2 C1	130	19¼ × 12	1 G2 " 2-⅝ "	33.896	239.81	2308.2	1279.19	1023.35
103	G2 C2	227	19¼ × 16	2 G2 " 2-⅝ "	57.79	386.57	3720.76	2061.72	1649.37

Plate.	Number of Section.	Weight per Foot in Lbs.	Sizes in Inches.	Compounded of	Area in Square Inches.	Moments of Resistance in Square Inches.	Vertical or Greatest Moments of Inertia.	Distributed Load in Tons that One Foot will carry.	
								Coefficients of Stress. (See page 1.)	
								b.	c.
104	G2 C3	340	19½ × 24	3 G2 and 2- $\frac{5}{8}$ in. plates	86.68	579.85	5581.15	3092.59	2474.07
105	G2 C4	180	20½ × 12	1 G2 ,, 4- $\frac{5}{8}$,,	47.64	376.48	3859.0	2007.94	1606.35
106	G2 C5	294	20½ × 16	2 G2 ,, 4- $\frac{5}{8}$,,	75.28	560.47	5744.9	2989.22	2391.37
107	G2 C6	440	20½ × 24	3 G2 ,, 4- $\frac{5}{8}$,,	112.93	840.72	8617.38	4483.84	3587.07
108	G2 C7	390	21¾ × 16	2 G2 ,, 6- $\frac{5}{8}$,,	92.79	745.32	8105.39	3975.06	3180.04
109	G2 C8	540	21¾ × 24	3 G2 ,, 6- $\frac{5}{8}$,,	139.18	1117.98	12158.09	5962.59	4770.07
110	G3 C1	98	17 × 10	1 G3 ,, 2- $\frac{1}{2}$,,	25.53	151.66	1289.16	808.89	647.11
111	G3 C2	178½	17 × 14	2 G3 ,, 2- $\frac{1}{2}$,,	45.06	253.83	2157.58	1353.78	1083.02
112	G3 C3	236	17 × 20	3 G3 ,, 2- $\frac{1}{2}$,,	66.59	372.37	3165.18	1986.67	1589.33
113	G3 C4	132	18 × 10	1 G3 ,, 4- $\frac{1}{2}$,,	34.53	230.41	2073.75	1228.89	983.11
114	G3 C5	271	19 × 14	2 G3 ,, 6- $\frac{1}{2}$,,	69.06	469.83	4463.42	2505.78	2004.62
115	G3 C6	394	19 × 20	3 G3 ,, 6- $\frac{1}{2}$,,	100.59	678.5	6445.75	3618.67	2894.83
116	G5 C1	77	16 × 10	1 G5 ,, 2- $\frac{1}{2}$,,	20.03	116.03	928.27	618.85	495.08
117	G5 C2	127	16 × 12	2 G5 ,, 2- $\frac{1}{2}$,,	32.06	170.04	1360.54	907.03	725.62
118	G5 C3	191	16 × 18	3 G5 ,, 2- $\frac{1}{2}$,,	48.09	255.1	2040.82	1360.55	1088.44

Plate.	Number of Section.	Weight per Foot in Lbs.	Sizes in Inches.	Compounded of	Area in Square Inches.	Moments of Resistance in Square Inches.	Vertical or Greatest Moments of Inertia.	Distributed Load in Tons that One Foot will carry.	
								Coefficients of Stress. (See page 1.)	
								b.	c.
119	G5 C4	111½	17 × 10	1 G5 and 4- $\frac{1}{2}$ in. plates	29.03	190.33	1617.38	1014.83	811.86
120	G5 C5	210	18 × 12	2 G5 ,, 6- $\frac{1}{2}$,,	52.06	340.06	3060.61	1813.7	1450.96
121	G5 C6	315	18 × 18	3 G5 ,, 6- $\frac{1}{2}$,,	78.09	510.1	4590.92	2720.55	2176.44
122	G6 C1	142	14½ × 15	2 G6 ,, 1- $\frac{1}{2}$,,	38.22	168.38	1338.46	898.33	718.66
122	G6 C2	93	15 × 10	1 G6 ,, 2- $\frac{1}{2}$,,	24.01	128.39	962.95	684.77	547.81
123	G6 C3	164	15 × 14	2 G6 ,, 2- $\frac{1}{2}$,,	42.02	213.42	1599.66	1137.54	910.03
123	G6 C4	245	15 × 20	3 G6 ,, 2- $\frac{1}{2}$,,	62.03	312.68	2345.11	1667.64	1334.11
124	G6 C5	127	16 × 10	1 G6 ,, 4- $\frac{1}{2}$,,	33.01	198.14	1585.15	1056.77	845.41
124	G6 C6	212	16 × 14	2 G6 ,, 4- $\frac{1}{2}$,,	54.02	306.29	2450.31	1633.54	1306.83
125	G6 C7	326	16 × 20	3 G6 ,, 4- $\frac{1}{2}$,,	79.03	444.43	3555.46	2370.31	1896.24
125	G8 C1	50½	12¾ × 8	1 G8 ,, 1- $\frac{3}{8}$,,	13.38	48.34	340.59	257.83	206.26
126	G8 C2	96	12¾ × 12	2 G8 ,, 1- $\frac{3}{8}$,,	25.26	91.1	614.98	485.9	388.72
126	G8 C3	141	12¾ × 16	3 G8 ,, 1- $\frac{3}{8}$,,	37.13	133.83	886.66	713.78	571.02
127	G8 C4	75	13 × 10	1 G8 ,, 2- $\frac{1}{2}$,,	19.30	93.84	609.97	500.49	400.39
127	G8 C5	121	13 × 12	2 G8 ,, 2- $\frac{1}{2}$,,	30.68	137.68	894.94	734.31	587.44

Plate.	Number of Section.	Weight per Foot in Lbs.	Sizes in Inches.	Compuanded of	Area in Square Inches.	Moments of Resistance in Square Inches.	Vertical or Greatest Moments of Inertia.	Distributed Load in Tons that One Foot will carry.	
								Coefficients of Stress. (See page 1.)	
								b.	c.
128	G8 C6	182	13 × 18	3 G8 and 2-½ in. plates . . .	46.06	206.52	1342.41	1101.47	881.17
128	G8 C7	108	14 × 10	1 G8 ,, 4-½ ,, . . .	28.52	155.85	1091.0	831.24	664.99
129	G8 C8	162	14 × 12	2 G8 ,, 4-½ ,, . . .	41.08	207.7	1454.0	1107.81	886.24
129	G8 C9	244	14 × 18	3 G8 ,, 4-½ ,, . . .	61.62	311.55	2181.0	1661.72	1329.37
130	G10 C1	46½	10⅜ × 8	1 G10 ,, 1-⅜ ,, . . .	12.44	35.25	209.61	187.94	150.35
130	G10 C2	87	10⅜ × 12	2 G10 ,, 1-⅜ ,, . . .	23.38	68.93	390.67	367.66	294.15
131	G10 C3	56½	10¼ × 8	1 G10 ,, 2-⅜ ,, . . .	14.66	55.37	297.66	295.34	236.27
131	G10 C4	103	10¼ × 12	2 G10 ,, 2-⅜ ,, . . .	26.32	95.18	511.6	507.64	406.11
132	G10 C5	170	11 × 18	3 G10 ,, 2-½ ,, . . .	39.72	163.94	901.67	874.35	699.48
132	G10 C6	76½	11½ × 8	1 G10 ,, 4-⅜ ,, . . .	20.06	83.48	480.04	455.26	364.21
133	G10 C7	134	11½ × 12	2 G10 ,, 4-⅜ ,, . . .	34.12	138.47	796.21	738.52	590.81
133	G10 C8	231	12 × 18	3 G10 ,, 4-½ ,, . . .	51.46	253.42	1520.56	1351.6	1081.28

N.B.—The weights per foot are approximate only, and we do not guarantee to deliver girders exactly to them, as in rolling they will vary a little.

SPECIAL NOTE.—In all our tables we give the strengths of the girders to spans up to 20 times the depth; they are frequently used beyond these limits, but are not recommended.

Tables of Safe Distributed Loads in Tons, on Joist Compound Girders of Varying Spans.

Plate.	Number of Section.	Weight per Foot in Lbs.	Safe Coefficient. (See page 1.)	Clear Spans in Feet between Supports.												
				20'	22'	24'	26'	28'	30'	32'	34'	36'	38'			
93	G1 C1	144	b	76	69	63	59	54	51	48	45	42	40			
			c	61	55	51	47	43	40	38	36	34	32			
94	G1 C2	260	b	132	120	110	102	94	88	83	78	74	69			
			c	106	96	88	81	75	70	66	62	59	55			
95	G1 C3	377	b	188	170	157	145	134	125	118	111	104	99			
			c	151	137	125	116	107	100	94	88	84	79			
96	G1 C4	195	b	116	106	97	89	83	77	73	68	64	61			
			c	93	85	77	71	66	62	58	55	51	49			
97	G1 C5	335	b	191	174	159	147	136	127	119	112	106	100			
			c	152	139	127	117	109	101	95	89	84	80			
98	G1 C6	450	b	265	241	221	204	189	176	165	156	147	139			
			c	212	193	177	163	151	141	132	124	118	111			
99	G1 C7	248	b	159	144	132	122	113	106	99	93	88	83			
			c	127	115	106	98	91	84	79	74	70	67			
100	G1 C8	414	b	252	229	210	194	180	168	158	148	140	133			
			c	202	183	168	155	144	134	126	119	112	106			
101	G1 C9	582	b	346	314	288	266	247	230	216	203	195	182			
			c	277	251	230	213	198	184	173	163	153	145			

Loads in Tons.

Plate.	Number of Section.	Weight per Foot in Lbs.	Safe Coefficient. (See page 1.)	Clear Spans in Feet between Supports.									
				16'	18'	20'	22'	24'	26'	28'	30'	32'	34'
102	G2 C1	130	<i>b</i>		71	64	58	53	49	45	42	40	37
			<i>c</i>		56	51	46	42	39	36	34	32	30
103	G2 C2	227	<i>b</i>		114	103	93	86	79	73	68	64	60
			<i>c</i>		91	82	75	68	63	58	55	51	48
104	G2 C3	340	<i>b</i>		171	154	140	128	119	110	103	96	91
			<i>c</i>		137	123	112	103	95	88	82	77	72
105	G2 C4	180	<i>b</i>		111	100	91	83	77	71	67	62	59
			<i>c</i>		89	80	73	67	61	57	53	50	47
106	G2 C5	294	<i>b</i>		166	149	135	124	115	106	99	93	88
			<i>c</i>		132	119	108	99	92	85	79	74	70
107	G2 C6	440	<i>b</i>		249	224	203	186	172	160	149	140	131
			<i>c</i>		193	179	163	149	138	128	119	112	105
108	G2 C7	360	<i>b</i>		220	198	179	165	152	142	132	124	117
			<i>c</i>		176	159	144	132	122	113	106	99	93
109	G2 C8	540	<i>b</i>		331	298	271	248	229	213	198	186	175
			<i>c</i>		265	238	216	198	183	170	159	149	140
110	G3 C1	98	<i>b</i>	50	44	40	36	33	31	28	27	25	
			<i>c</i>	40	36	32	29	27	24	23	21	20	
111	G3 C2	178½	<i>b</i>	84	75	67	61	56	52	48	45	42	
			<i>c</i>	67	60	54	49	45	41	38	36	33	
112	G3 C3	266	<i>b</i>	124	110	99	90	83	76	70	66	62	
			<i>c</i>	99	88	79	72	66	61	56	53	49	

Loads in Tons.

Plate.	Number of Section.	Weight per Foot in Lbs.	Safe Coefficient. (See page 1.)	Clear Spans in Feet between Supports.									
				14'	16'	18'	20'	22'	24'	26'	28'	30'	32'
113	G3 C4	132	<i>b</i>		76	69	61	55	51	47	43	41	38
			<i>c</i>		61	54	49	44	41	37	35	32	30
114	G3 C5	271	<i>b</i>		156	139	125	113	104	96	89	83	78
			<i>c</i>		125	111	100	91	83	77	71	66	62
115	G3 C6	394	<i>b</i>		226	201	181	164	150	139	129	120	113
			<i>c</i>		180	160	145	131	120	111	103	96	90
116	G5 C1	77	<i>b</i>	44	38	34	30	28	25	23	22	20	
			<i>c</i>	35	31	27	25	22	20	19	17	16	
117	G5 C2	127	<i>b</i>	64	56	50	45	41	37	34	32	30	
			<i>c</i>	51	45	40	36	33	30	27	25	24	
118	G5 C3	191	<i>b</i>	97	85	75	68	62	56	52	48	45	
			<i>c</i>	77	68	60	54	49	45	41	38	36	
119	G5 C4	111¼	<i>b</i>	72	63	56	50	46	42	39	36	33	
			<i>c</i>	58	50	45	40	36	33	31	29	27	
120	G5 C5	210	<i>b</i>	129	113	100	90	82	75	69	64	60	
			<i>c</i>	103	90	80	72	66	60	56	52	48	
121	G5 C6	315	<i>b</i>	193	172	151	136	123	113	104	96	90	
			<i>c</i>	155	136	120	108	99	90	83	77	72	
122	G6 C1	142	<i>b</i>	64	56	49	45	40	37	34	32		
			<i>c</i>	51	44	39	36	32	30	27	25		
122	G6 C2	93	<i>b</i>	48	42	38	34	31	28	26	24		
			<i>c</i>	39	34	30	27	24	22	21	19		

Loads in Tons.

Plate.	Number of Section.	Weight per Foot in Lbs.	Safe Coefficient. (See page 1.)	Clear Spans in Feet between Supports.								
				12'	14'	16'	18'	20'	22'	24'	26'	23'
123	G6 C3	164	<i>b</i>		81	71	63	56	51	47	43	40
			<i>c</i>		65	56	50	45	41	38	35	32
123	G6 C4	245	<i>b</i>		119	104	92	83	75	69	64	59
			<i>c</i>		95	83	74	66	60	55	51	47
124	G6 C5	127	<i>b</i>		75	66	58	52	48	44	40	37
			<i>c</i>		60	52	47	42	38	35	32	30
124	G6 C6	212	<i>b</i>		116	102	90	81	74	68	62	58
			<i>c</i>		93	81	72	65	59	54	50	46
125	G6 C7	326	<i>b</i>		169	148	131	118	107	99	92	85
			<i>c</i>		134	118	105	94	86	79	73	67
125	G8 C1	50½	<i>b</i>	21	18	16	14	12	11	10		
			<i>c</i>	17	14	12	11	10	9	8		
126	G8 C2	96	<i>b</i>	40	34	30	27	24	22	20		
			<i>c</i>	32	27	24	21	19	17	16		
126	G8 C3	141	<i>b</i>	59	51	44	39	35	32	29		
			<i>c</i>	47	40	35	31	28	26	23		
127	G8 C4	75	<i>b</i>	41	35	31	27	25	23	20		
			<i>c</i>	33	28	25	22	20	18	16		
127	G8 C5	121	<i>b</i>	61	52	45	40	36	33	30		
			<i>c</i>	49	42	36	32	29	26	24		
128	G8 C6	182	<i>b</i>	91	78	68	61	55	50	45		
			<i>c</i>	73	63	55	49	44	40	36		

Loads in Tons.

Plate.	Number of Section.	Weight per Foot in Lbs.	Safe Coefficient. (See page 1.)	Clear Spans in Feet between Supports.								
				10'	12'	14'	16'	18'	20'	22'	24'	
128	G8 C7	108	<i>b</i>		69	59	52	46	41	37	34	
			<i>c</i>		55	47	41	36	33	30	27	
129	G8 C8	162	<i>b</i>		92	79	69	61	55	50	46	
			<i>c</i>		72	63	55	49	44	40	37	
129	G8 C9	244	<i>b</i>		138	118	103	92	83	75	69	
			<i>c</i>		110	95	83	73	66	60	55	
130	G10 C1	46½	<i>b</i>	18	15	13	11	10	9			
			<i>c</i>	15	12	10	9	8	7			
130	G10 C2	87	<i>b</i>	36	30	26	23	20	18			
			<i>c</i>	29	24	21	18	16	14			
131	G10 C3	56½	<i>b</i>	29	24	21	18	16	15			
			<i>c</i>	23	19	16	14	13	11			
131	G10 C4	103	<i>b</i>	50	42	36	31	28	25			
			<i>c</i>	40	33	29	24	22	20			
132	G10 C5	170	<i>b</i>	87	73	62	54	48	43			
			<i>c</i>	70	58	49	43	38	35			
132	G10 C6	76½	<i>b</i>	45	38	32	28	25	22			
			<i>c</i>	36	30	26	22	20	18			
133	G10 C7	134	<i>b</i>	73	61	52	46	41	37			
			<i>c</i>	59	49	42	36	32	29			
133	G10 C8	231	<i>b</i>	135	112	96	85	75	67			
			<i>c</i>	108	90	77	67	60	54			

Loads in Tons.

TABLE OF CHANNELS, GIVING THE WEIGHTS, SIZES, MOMENTS OF RESISTANCE AND INERTIA, AND LOADS THAT ONE FOOT WILL CARRY.

Plate.	Number of Section.	Weight per Foot in Lbs.	Normal Sizes in Inches.	Dimensions in Inches.		Square Inches Area.	Moments of Resistance in Square Inches.	Vertical or Greatest Moments of Inertia.	Distributed Load in Tons that One Foot will carry.	
				Web.	Flange.				Coefficients of Stress. (See page 1.)	
									b.	c.
52	C12 ^a	31.86	12 × 3½	½	9/16	9.37	30.41	182.46	162.18	129.74
52	C12	30.6	12 × 3½	½	½	9.0	28.54	171.25	152.22	121.77
52	C11 ^a	27.39	10 × 4	½	7/16	8.06	22.34	111.72	119.16	95.33
53	C11	22.49	10 × 3	7/16	7/16	6.61	17.55	87.75	93.6	74.88
53	C9	23.79	8 × 3½	½	½	7.0	15.89	63.58	84.77	67.81
53	C9 ^a	24.39	7 7/8 × 3 3/4	½	½	7.18	16.4	64.09	87.51	70.0
53	C8 ^a	22.07	7 × 3½	½	½	6.5	13.15	46.04	70.15	56.12
54	C8	20.4	7 × 3	½	½	6.0	11.64	40.75	62.09	49.67
54	C7	26.55	6 × 3 7/8	5/8	5/8	7.81	13.575	40.725	72.4	57.92
54	C6	15.69	6 × 3	3/8	7/16	4.54	8.185	24.556	43.65	34.92
54	C6 ^a	15.01	6 × 2½	7/16	7/16	4.42	7.28	21.86	38.86	31.09
55	C5	15.86	5 1/8 × 2 7/8	7/16	½	4.67	7.02	17.99	37.44	29.95
55	C4	11.32	4 1/2 × 2	7/16	7/16	3.33	3.99	8.98	21.28	17.02
55	C2	16.36	4 × 3	½	9/16	4.81	5.525	11.05	29.46	23.57
55	C1	7.74	3 1/4 × 1 1/2	5/16	½	2.28	2.17	3.81	11.60	9.28
53	C10	18.45	9 × 3	3/8	3/8	5.34	13.2	59.42	70.42	56.33
53	C10 ^a	25.92	9 × 3½	½	½	7.5	18.8	84.625	100.29	80.23

CHANNEL COMPOUND GIRDERS.

Plate.	Number of Section.	Weight per Foot in Lbs.	Sizes in Inches.	Compounded of	Area in Square Inches.	Moments of Resistance in Square Inches.	Vertical or Greatest Moments of Inertia.	Distributed Load in Tons that One Foot will carry.	
								Coefficients of Stress. (See page 1.)	
								b.	c.
134	C12 C1	107	13 × 12	2 C 12 and 2-½ in. plates	26.72	102.31	665.02	545.65	436.52
134	C12 C2	112	13 × 14	2 C 12 ,, 2-½ ,,	27.72	114.32	743.12	609.73	487.79
135	C12 C3	118	13 × 16	2 C 12 ,, 2-½ ,,	30.72	126.34	821.26	673.85	539.08
135	C12 C4	147	14 × 12	2 C 12 ,, 4-½ ,,	37.08	162.25	1135.78	865.35	692.28
136	C12 C5	161	14 × 14	2 C 12 ,, 4-½ ,,	41.08	186.39	1304.78	994.11	795.28
136	C12 C6	175	14 × 16	2 C 12 ,, 4-½ ,,	45.08	210.54	1473.78	1122.88	898.3
137	C11 C1	88	11 × 12	2 C 11 ,, 2-½ ,,	22.18	75.38	414.62	402.05	321.64
137	C11 C2	95	11 × 14	2 C 11 ,, 2-½ ,,	24.18	85.4	469.74	455.5	364.4
138	C11 C3	102	11 × 16	2 C 11 ,, 2-½ ,,	26.18	95.42	524.86	508.95	407.10
138	C11 C4	130	12 × 12	2 C 11 ,, 4-½ ,,	32.54	125.98	755.88	671.89	537.51
139	C11 C5	144	12 × 14	2 C 11 ,, 4-½ ,,	36.54	146.14	876.88	779.44	623.55
139	C11 C6	158	12 × 16	2 C 11 ,, 4-½ ,,	40.54	166.31	997.88	887.0	709.6

Tables of Safe Distributed Loads in Tons, on Channel Compound Girders of Varying Spans.

Plate.	Number of Section.	Weight per Foot in Lbs.	Safe Coefficient. (See page 1.)	Clear Spans in Feet between Supports.									
				10'	12'	14'	16'	18'	20'	22'			
134	C12 C1	107	b	54	45	39	34	30	27	27			
			c	43	36	31	27	24	21				
134	C12 C2	112	b	60	50	43	38	33	30				
			c	48	40	34	30	27	24				
135	C12 C3	118	b	67	56	48	42	37	33				
			c	53	45	38	33	29	26		39		
135	C12 C4	147	b	72	61	54	48	43	38	34	31		
			c	57	49	43	38	33	29	26	22		
136	C12 C5	161	b	82	71	62	55	49	45				
			c	66	56	49	44	40	36		40		
136	C12 C6	175	b	93	80	70	62	56	51				
			c	74	64	56	49	44	40		40		
137	C11 C1	88	b	40	33	28	25	22					
			c	32	26	23	20	17					
137	C11 C2	95	b	45	38	32	28	25					
			c	36	30	26	22	20					
138	C11 C3	102	b	50	42	36	31	28					
			c	40	34	29	25	22					
138	C11 C4	130	b	67	56	48	42	37	33				
			c	53	44	38	33	29	26				
139	C11 C5	144	b	77	65	55	48	43	39	35			
			c	62	52	44	39	34	31				
139	C11 C6	158	b	88	74	63	55	49	44				
			c	70	59	50	44	39	35				

Loads in Tons.

BENDING MOMENTS AND DEFLECTIONS OF BEAMS, UNDER VARIOUS SYSTEMS OF LOADING.

W = total load
 l = length of beam

I = moment of Inertia
 E = modulus of elasticity

1 Beam fixed at one end and loaded at the other.

Safe load = $\frac{1}{8}$ that given in tables.
 Maximum bending moment at point of support = $W \cdot l$.
 Maximum shear at point of support = W .
 Deflection = $\frac{W l^3}{3 E I}$

2 Beam fixed at one end and uniformly loaded.

Safe load = $\frac{1}{4}$ that given in tables.
 Maximum bending moment at point of support = $\frac{W l}{2}$.
 Maximum shear at point of support = W .
 Deflection = $\frac{W l^3}{8 E I}$

3 Beam supported at both ends single load in the middle.

Safe load = $\frac{1}{2}$ that given in tables.
 Maximum bending moment at middle of beam = $\frac{W l}{4}$.
 Maximum shear at points of support = $\frac{1}{2} W$.
 Deflection = $\frac{W l^3}{48 E I}$.

4 Beam supported at both ends and uniformly loaded.

Safe load = that given in tables
 Maximum bending moment at middle of beam = $\frac{W l}{8}$.
 Maximum shear at points of support = $\frac{1}{2} W$.
 Deflection = $\frac{W l^3}{76.8 E I}$.

5 Beam supported at both ends, single unsymmetrical load.

Safe load = that given in tables $\times \frac{l^2}{8 a b}$
 Maximum bending moment under load = $\frac{W a b}{l}$
 Maximum shears: at support near $a = \frac{W b}{l}$; at other support = $\frac{W a}{l}$
 Max. Deflection = $\frac{W a b (2 l - a)}{9 E I l} \sqrt{\frac{1}{3} a (2 b - a)}$

6 Beam supported at both ends, two symmetrical loads.

Safe load = that given in tables $\times \frac{l}{4 a}$.
 Maximum bending moment between loads = $\frac{1}{4} W a$.
 Maximum shear between load and nearer support = $\frac{1}{2} W$
 Max. Deflection = $\frac{W a}{48 E I} (3 l^2 - 4 a^2)$

Moments of Inertia for several Sections.

Sections	Inertias
	$I = \frac{BD^3 - 2bd^3}{12}$
	$J = \frac{2tb^3 + h'b'^3}{12}$
	$I = \frac{BD^3 - bd^3}{12}$
	$I = \frac{bd^3 - 8c(h - \frac{1}{2}d)^3}{12}$
	$y = \frac{d}{2} + \frac{\frac{1}{2}BDT}{BT + dt}$ $I = \frac{B(x^2 - z^3) + t(y^3 + z^3)}{3}$

DORMAN, LONG & COMPANY, LIMITED, MIDDLESBOROUGH.

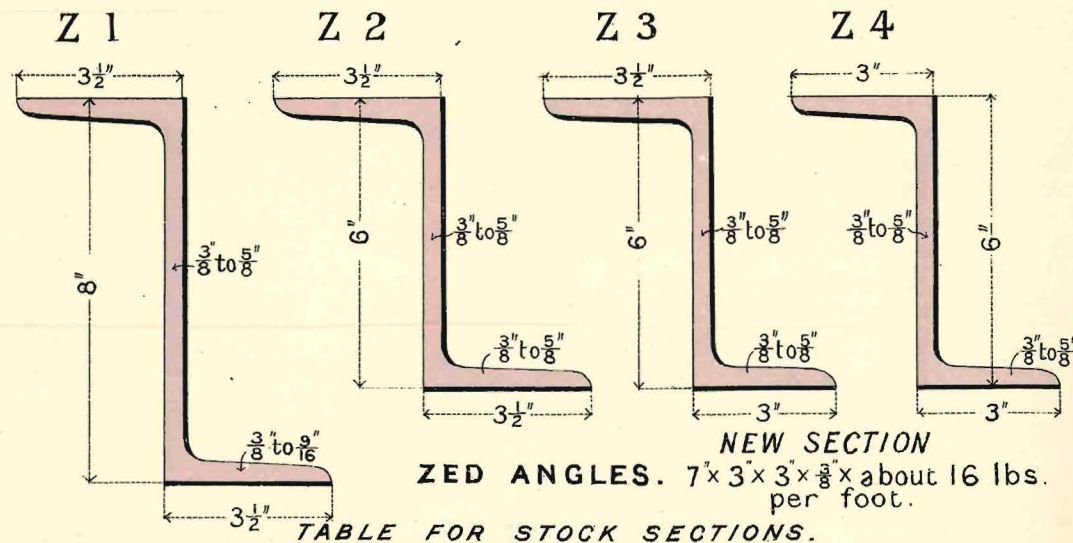

Nº OF SECTION	WEIGHT PER FOOT IN POUNDS	NORMAL SIZES IN INCHES	DIMENSIONS IN INCHES		SQUARE INCHES AREA	MOMENTS OF RESISTANCE IN SQUARE INCHES	VERTICAL OR GREATEST MOMENTS OF INERTIA	DISTRIBUTED LOAD IN TONS THAT ONE FOOT WILL CARRY COEFFICIENTS OF STRESS SEE PAGE I.	
			WEB	FLANGE				b	c
Z 1	18 · 15	8 x 3 1/2 x 3 1/2	3/8	3/8	5 · 34	12 · 52	50 · 1	66 · 8	53 · 44
Z 2	15 · 61	6 x 3 1/2 x 3 1/2	"	"	4 · 59	8 · 44	25 · 33	45 · 03	36 · 02
Z 3	14 · 96	6 x 3 1/2 x 3	"	"	4 · 40	7 · 94	23 · 84	42 · 38	33 · 9
Z 4	14 · 31	6 x 3 x 3	"	"	4 · 21	7 · 45	22 · 36	39 · 75	31 · 8

DORMAN, LONG & COMPANY, LIMITED, MIDDLESBOROUGH.

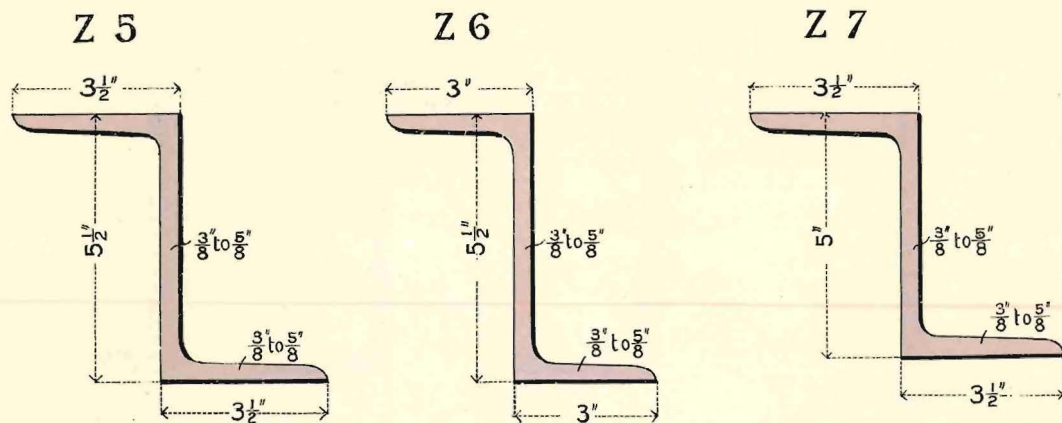

ZED ANGLES

Also $5\frac{1}{2} \times 2\frac{3}{4} \times 2\frac{3}{4}$, flanges $\frac{1}{2}$ to $\frac{3}{4}$ ", web, $\frac{3}{8}$ " to $\frac{5}{8}$ " thick.

TABLE FOR STOCK SECTIONS.

N° OF SECTION	WEIGHT PER FOOT IN POUNDS	NORMAL SIZES IN INCHES	DIMENSIONS IN INCHES		SQUARE INCHES AREA	MOMENTS OF RESISTANCE IN SQUARE INCHES	VERTICAL OR GREATEST MOMENTS OF INERTIA	DISTRIBUTED LOAD IN TONS THAT ONE FOOT WILL CARRY COEFFICIENTS OF STRESS. SEE PAGE 1.	
			WEB	FLANGE				b	c
Z 5	14.7	$5\frac{1}{2} \times 3\frac{1}{2} \times 3\frac{1}{2}$	$\frac{3}{8}$	$\frac{3}{8}$	4.31	7.3	20.06	38.96	31.69
Z 6	13.69	$5\frac{1}{2} \times 3 \times 3$	"	"	4.03	6.6	18.16	35.21	28.17
Z 7	14.34	$5 \times 3\frac{1}{2} \times 3\frac{1}{2}$	"	"	4.21	6.6	16.5	35.2	28.16

DORMAN, LONG & COMPANY, LIMITED, MIDDLESBOROUGH.

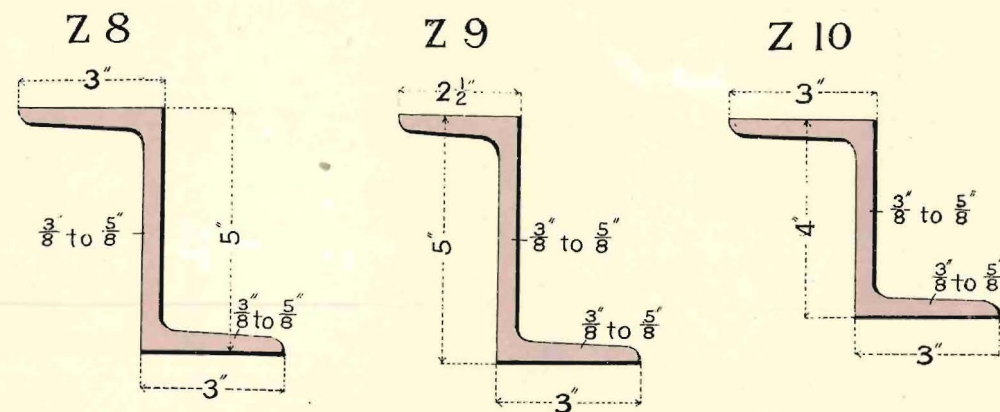

ZED ANGLES

TABLE FOR STOCK SECTIONS.

N° OF SECTION	WEIGHT PER FOOT IN POUNDS	NORMAL SIZES IN INCHES	DIMENSIONS IN INCHES		SQUARE INCHES AREA	MOMENTS OF RESISTANCE IN SQUARE INCHES	VERTICAL OR GREATEST MOMENTS OF INERTIA	DISTRIBUTED LOAD IN TONS THAT ONE FOOT WILL CARRY COEFFICIENTS OF STRESS. SEE PAGE 1.	
			WEB	FLANGE				b	c
Z 8	13.05	$5 \times 3 \times 3$	$\frac{3}{8}$	$\frac{3}{8}$	3.84	5.79	14.48	30.89	24.71
Z 9	12.42	$5 \times 3 \times 2\frac{1}{2}$	"	"	3.65	5.39	13.47	28.8	23.04
Z 10	11.78	$4 \times 3 \times 3$	"	"	3.46	4.24	8.49	22.6	18.1

CHANNELS

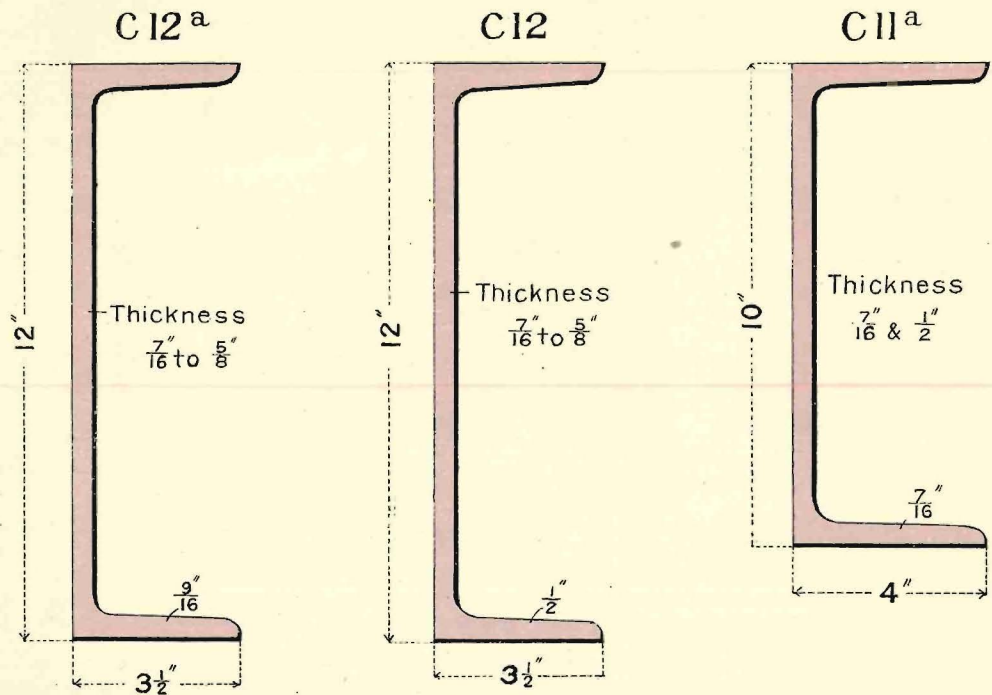
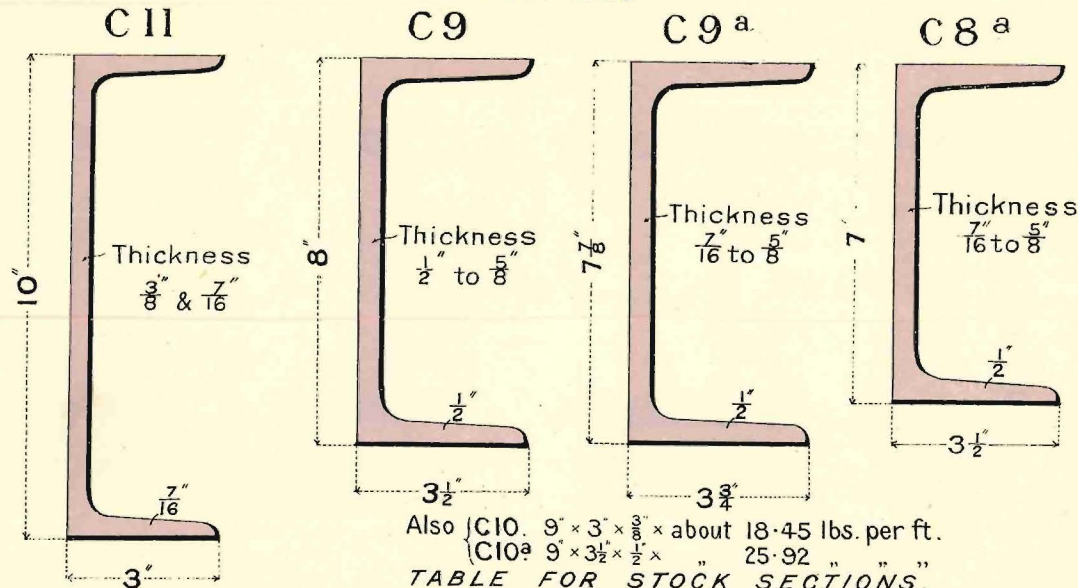

TABLE FOR STOCK SECTIONS.

N ^o OF SECTION	WEIGHT PER FOOT IN POUNDS	NORMAL SIZES IN INCHES	DIMENSIONS IN INCHES		SQUARE INCHES AREA	MOMENTS OF RESISTANCE IN SQUARE INCHES	VERTICAL OR GREATEST MOMENTS OF INERTIA	DISTRIBUTED LOAD IN TONS THAT ONE FOOT WILL CARRY COEFFICIENTS OF STRESS. SEE PAGE I.	
			WEB	FLANGE				b	c
C12 ^a	31.86	12 x 3 1/2	1/2	9/16	9.37	30.41	182.46	162.18	129.74
C12	30.6	12 x 3 1/2	"	1/2	9.0	28.54	171.25	152.22	121.77
C11 ^a	27.39	10 x 4	"	7/16	8.06	22.34	111.72	119.16	95.33

DORMAN, LONG & COMPANY, LIMITED, MIDDLESBOROUGH.

CHANNELS



N ^o OF SECTION	WEIGHT PER FOOT IN POUNDS	NORMAL SIZES IN INCHES	DIMENSIONS IN INCHES		SQUARE INCHES AREA	MOMENTS OF RESISTANCE IN SQUARE INCHES	VERTICAL OR GREATEST MOMENTS OF INERTIA	DISTRIBUTED LOAD IN TONS THAT ONE FOOT WILL CARRY COEFFICIENTS OF STRESS SEE PAGE I.	
			WEB	FLANGE				b	c
C11	22.49	10 x 3	7/16	7/16	6.61	17.55	87.75	93.6	74.88
C9	23.79	8 x 3 1/2	1/2	1/2	7.0	15.89	63.58	84.77	67.81
C9 ^a	24.39	7 7/8 x 3 3/4	"	"	7.18	16.4	64.609	87.51	70.0
C8 ^a	22.07	7 x 3 1/2	"	"	6.5	13.15	46.04	70.15	56.12

DORMAN, LONG & COMPANY, LIMITED, MIDDLESBOROUGH.

CHANNELS

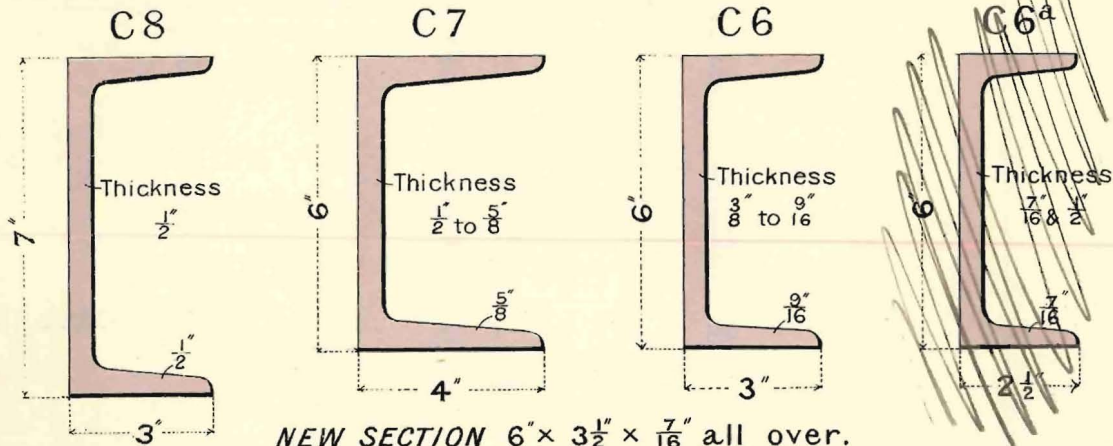

NEW SECTION 6" x 3 1/2" x 7/16" all over.

TABLE FOR STOCK SECTIONS.

N ^o OF SECTION	WEIGHT PER FOOT IN POUNDS	NORMAL SIZES IN INCHES	DIMENSIONS IN INCHES		SQUARE INCHES AREA	MOMENTS OF RESISTANCE IN SQUARE INCHES	VERTICAL OR GREATEST MOMENTS OF INERTIA	DISTRIBUTED LOAD IN TONS THAT ONE FOOT WILL CARRY COEFFICIENTS OF STRESS SEE PAGE I.	
			WEB	FLANGE				b	c
C 7	26.55	6 x 4	5/8	5/8	7.81	13.575	40.725	72.4	57.92
C 6	15.69	6 x 3	3/8	7/16	4.54	8.185	24.556	43.65	34.92
C 6a	15.01	6 x 2 1/2	7/16	7/16	4.42	7.28	21.86	38.86	31.09

DORMAN, LONG & COMPANY, LIMITED, MIDDLESBOROUGH.

CHANNELS.

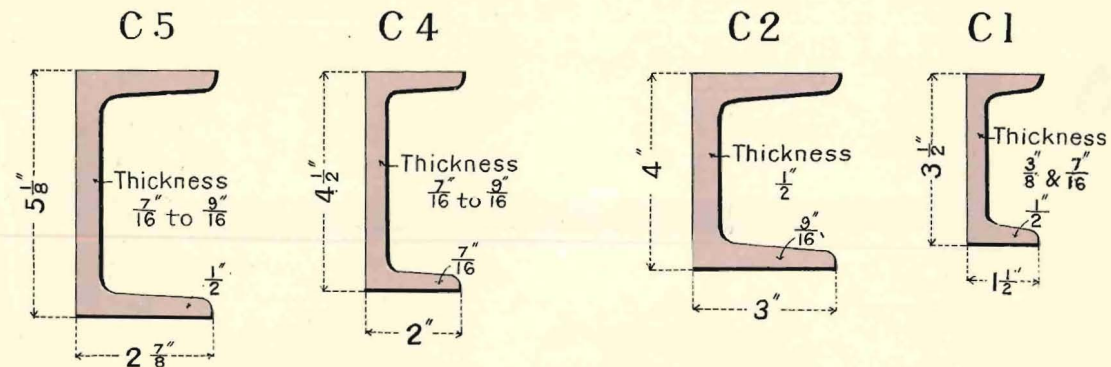
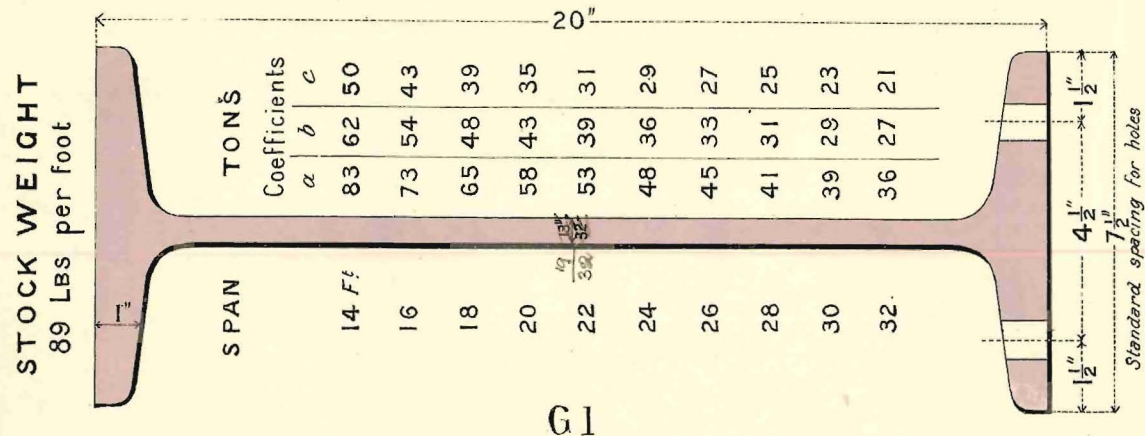

TABLE FOR STOCK SECTIONS.

N ^o OF SECTION	WEIGHT PER FOOT IN POUNDS	NORMAL SIZES IN INCHES	DIMENSIONS IN INCHES		SQUARE INCHES AREA	MOMENTS OF RESISTANCE IN SQUARE INCHES	VERTICAL OR GREATEST MOMENTS OF INERTIA	DISTRIBUTED LOAD IN TONS THAT ONE FOOT WILL CARRY COEFFICIENTS OF STRESS. SEE PAGE I.	
			WEB	FLANGE				b	c
C 4	11.32	4 1/2 x 2	7/16	7/16	3.33	3.99	8.98	21.28	17.02
C 2	16.36	4 x 3	1/2	9/16	4.81	5.525	11.05	29.46	23.57
C 1	8.1	3 1/2 x 1 1/2	3/8	1/2	2.43	2.17	3.81	11.60	9.28

DORMAN, LONG & COMPANY, LIMITED, MIDDLESBOROUGH.

Distributed Loads in Tons for different spans, Coefficients a b & c



G1

PLATE 56	N° OF SECTION	WEIGHT PER FOOT IN POUNDS	DIMENSIONS IN INCHES			SQUARE INCHES AREA	MOMENTS OF RESISTANCE IN SQ INCHES	VERTICAL OR GREATEST MOMENTS OF INERTIA	HORIZONTAL OR LEAST MOMENTS OF INERTIA	DISTRIBUTED LOADS IN TONS THAT ONE FOOT WILL CARRY. COEFFICIENTS OF STRESS. SEE PAGE I.			
			NORMAL SIZES IN INCHES	DEPTH.	WEB THICKNESS					MEAN TH. OF FLANGE	a	b	c
	G1 +	92	20x7 1/2	20x7.56	.66	1.0	27.22						
Stock	G1	89	" x "	"x7.5	.6	"	26.2	164.66	1646.6	70.63	1170.91	878.18	702.54
	G1 -	88	" x "	"x7.48	.58	"	25.9						

Lengths usually kept in stock 20 to 40 feet.

DORMAN, LONG & COMPANY, LIMITED, MIDDLESBOROUGH.

Distributed Loads in Tons for different spans, Coefficients a b & c

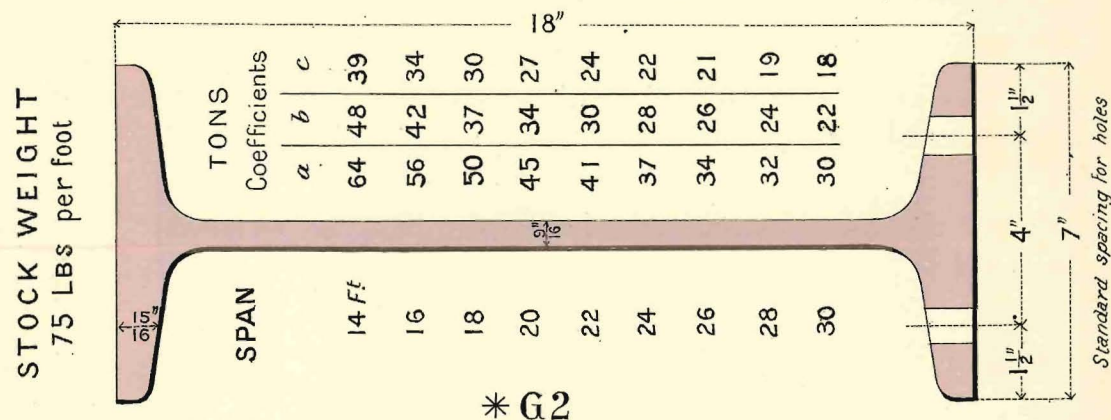

*G2

PLATE 57	N° OF SECTION	WEIGHT PER FOOT IN POUNDS	DIMENSIONS IN INCHES			SQUARE INCHES AREA	MOMENTS OF RESISTANCE IN SQ INCHES	VERTICAL OR GREATEST MOMENTS OF INERTIA	HORIZONTAL OR LEAST MOMENTS OF INERTIA	DISTRIBUTED LOADS IN TONS THAT ONE FOOT WILL CARRY. COEFFICIENTS OF STRESS. SEE PAGE I.			
			NORMAL SIZES IN INCHES	DEPTH	WEB THICKNESS					MEAN TH. OF FLANGE	a	b	c
	G2 +	82	18 x 7	18x7.11	.66	.94	24.12						
Stock	G2	75	" x "	"x7.	.55	"	22.06	127.83	1150.53	53.95	909.06	681.8	545.43
	G2 -	.74	" x "	"x6.98	.53	"	21.7						

Lengths usually kept in stock 20 to 45 feet

DORMAN, LONG & COMPANY, LIMITED, MIDDLESBOROUGH.

Distributed Loads in Tons for different spans, Coefficients a b & c

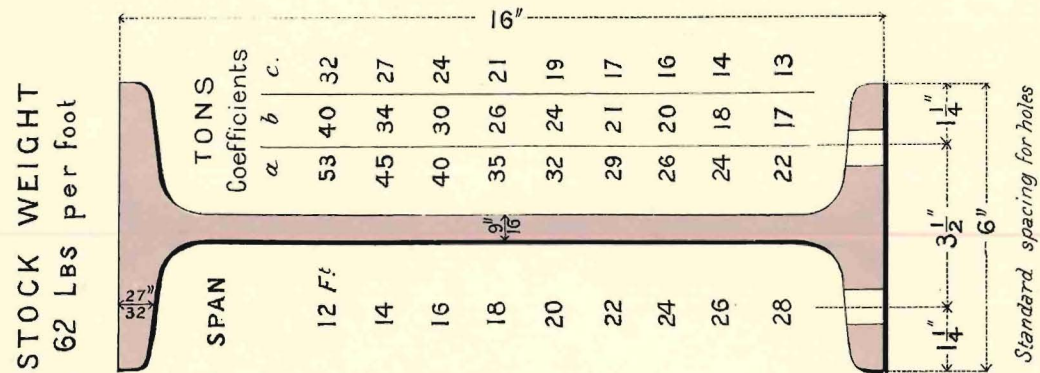

* G3

PLATE 58	N° OF SECTION	WEIGHT PER FOOT IN POUNDS	NORMAL SIZES IN INCHES	DIMENSIONS IN INCHES			SQUARE INCHES AREA	MOMENTS OF RESISTANCE IN SQ INCHES	VERTICAL OR GREATEST MOMENTS OF INERTIA	HORIZONTAL OR LEAST MOMENTS OF INERTIA	DISTRIBUTED LOADS IN TONS THAT ONE FOOT WILL CARRY. COEFFICIENTS OF STRESS. SEE PAGE 1.			
				DPHT	WDTH	WEB THICK- NESS					MEAN TH. OF FLANGE	a	b	c
	G 3 +	66	16 x 6	16 x 6.07	.63	.85	19.4							
Stock	G 3	62	" x "	" x 6	.56	"	18.23	90.29	722.36	30.8	642.09	481.57	385.25	
	G 3 -	60	" x "	" x 5.96	.52	"	17.64							

Lengths usually kept in stock 16 to 50 feet

DORMAN, LONG & COMPANY, LIMITED, MIDDLESBOROUGH.

Distributed Loads in Tons for different spans, Coefficients a b & c

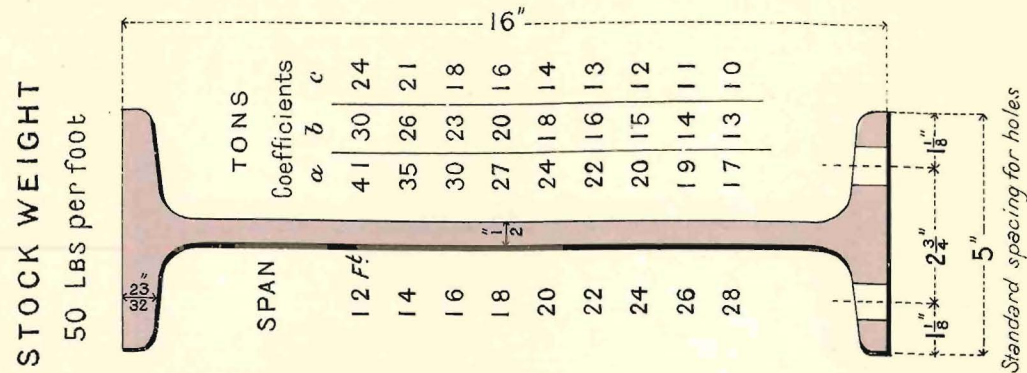

G3^a

PLATE 59	N° OF SECTION	WEIGHT PER FOOT IN POUNDS	NORMAL SIZES IN INCHES	DIMENSIONS IN INCHES			SQUARE INCHES AREA	MOMENTS OF RESISTANCE IN SQ INCHES	VERTICAL OR GREATEST MOMENTS OF INERTIA	HORIZONTAL OR LEAST MOMENTS OF INERTIA	DISTRIBUTED LOADS IN TONS THAT ONE FOOT WILL CARRY. COEFFICIENTS OF STRESS. SEE PAGE 1.			
				DPHT	WDTH	WEB THICK- NESS					MEAN TH. OF FLANGE	a	b	c
	G3 ^a +	54	16 x 5	16 x 5.07	.58	.73	15.88							
Stock	G3 ^a	50	" x "	" x 5	.51	"	14.7	69.56	556.51	15.36	494.67	371.01	296.80	
	G3 ^a -	"	" x "	" x "	"	"	"							

Lengths usually kept in stock 16 to 50 feet.

DORMAN, LONG & COMPANY, LIMITED, MIDDLESBOROUGH.

Distributed Loads in Tons for different spans, Coefficients a b & c

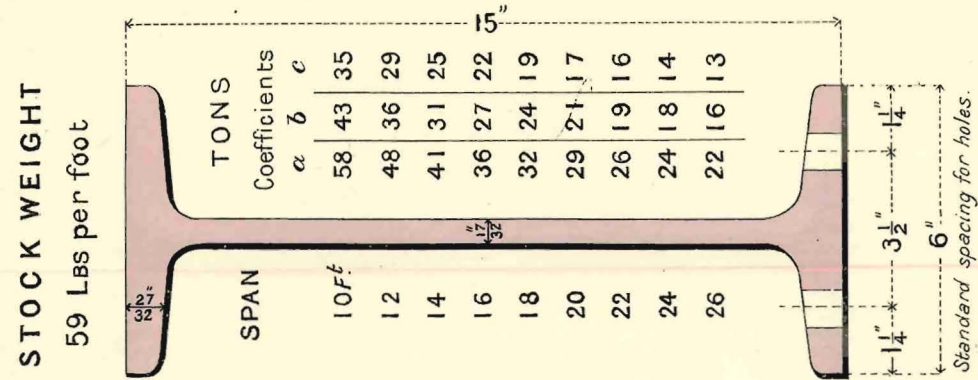

* G 4

PLATE 60	N° OF SECTION	WEIGHT PER FOOT IN POUNDS	NORMAL SIZES IN INCHES	DIMENSIONS IN INCHES			SQUARE INCHES AREA	MOMENTS OF RESISTANCE IN SQ INCHES	VERTICAL OR GREATEST MOMENTS OF INERTIA	HORIZONTAL OR LEAST MOMENTS OF INERTIA	DISTRIBUTED LOADS IN TONS THAT ONE FOOT WILL CARRY. COEFFICIENTS OF STRESS. SEE PAGE I.			
				DPTH	WDTH	WEB THICK- NESS					MEAN TH. OF FLANGE	a	b	c
	G4 +	62	15 x 6	15x6.06	.6	.85	18.23							
Stock	G4	59	" x "	"x6"	.54	"	17.35	82.27	617.05	30.76	585.05	438.79	351.03	
	G4 -	57	" x "	"x5.96	.5	"	16.75							

Lengths usually kept in stock 16 to 50 feet

DORMAN, LONG & COMPANY, LIMITED, MIDDLESBOROUGH.

Distributed Loads in Tons for different spans, Coefficients a b & c

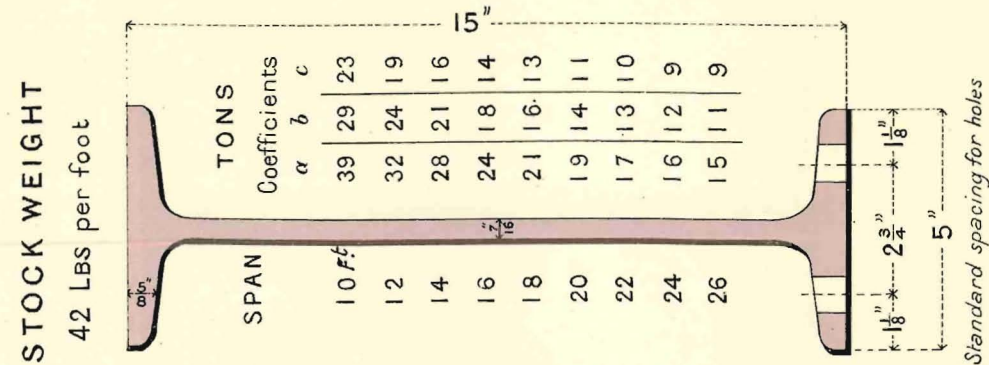

* G 5

PLATE 61	N° OF SECTION	WEIGHT PER FOOT IN POUNDS	NORMAL SIZES IN INCHES	DIMENSIONS IN INCHES			SQUARE INCHES AREA	MOMENTS OF RESISTANCE IN SQ INCHES	VERTICAL OR GREATEST MOMENTS OF INERTIA	HORIZONTAL OR LEAST MOMENTS OF INERTIA	DISTRIBUTED LOADS IN TONS THAT ONE FOOT WILL CARRY. COEFFICIENTS OF STRESS. SEE PAGE I.			
				DPTH	WDTH	WEB THICK- NESS					MEAN TH. OF FLANGE	a	b	c
	G5 +	44	15 x 5	15x5.048	.47	.625	13.0							
Stock	G5	42	" x "	"x5"	.422	"	12.28	55.26	414.51	13.1	393.01	294.76	235.81	
	G5 -	40	" x "	"x4.968	.39	"	11.8							

Lengths usually kept in stock 16 to 45 feet.

DORMAN, LONG & COMPANY, LIMITED, MIDDLESBOROUGH.

Distributed Loads in Tons for different spans, Coefficients a b & c

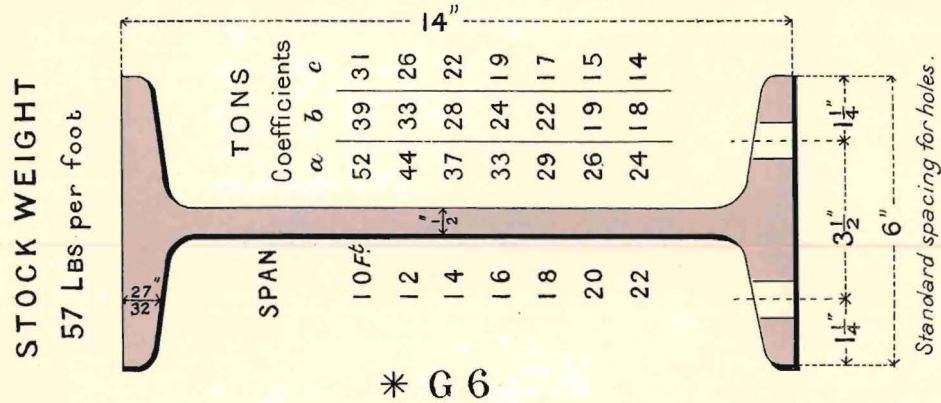

PLATE 62	N° OF SECTION	WEIGHT PERFECT IN POUNDS	NORMAL SIZES IN INCHES	DIMENSIONS IN INCHES			SQUARE INCHES AREA	MOMENTS OF RESISTANCE IN SQ INCHES	VERTICAL OR GREATEST MOMENTS OF INERTIA	HORIZONTAL OR LEAST MOMENTS OF INERTIA	DISTRIBUTED LOADS IN TONS THAT ONE FOOT WILL CARRY. COEFFICIENTS OF STRESS. SEE PAGE 1.		
				DPHT	WDTH	WEB THICK-NESS					MEAN TH. OF FLANGE	a	b
	G 6 +	61	14x6	14x6.09	.6	.85	17.96						
Stock	G 6	57	» x »	»x6.0	.51	»	16.17	74.38	520.65	30.73	528.91	396.38	317.34
	G 6 -	53	» x »	»x5.92	.43	»	15.58						
Also	G 6 ^c	82	14x6	14x6	1.0	1.0		special section for Piles.					

Lengths usually kept in stock 14 to 45 feet.

DORMAN, LONG & COMPANY, LIMITED, MIDDLESBOROUGH.

Distributed Loads in Tons for different spans, Coefficients a b & c

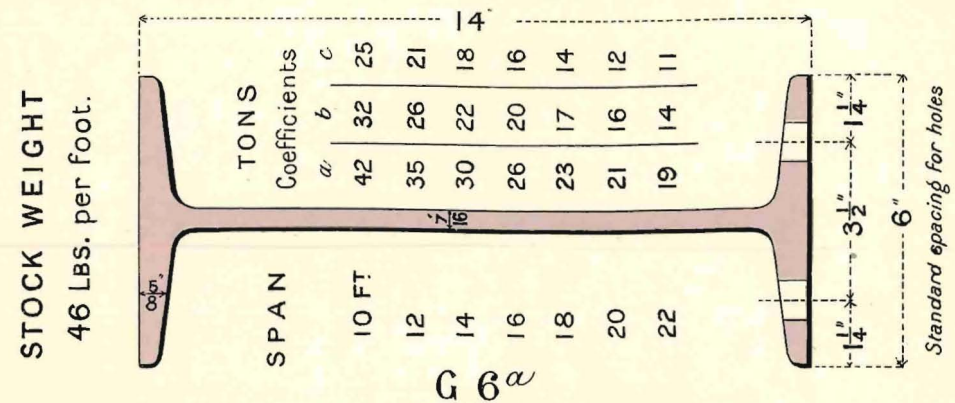

PLATE 63	N° OF SECTION	WEIGHT PERFECT IN POUNDS	NORMAL SIZES IN INCHES	DIMENSIONS IN INCHES			SQUARE INCHES AREA	MOMENTS OF RESISTANCE IN SQ INCHES	VERTICAL OR GREATEST MOMENTS OF INERTIA	HORIZONTAL OR LEAST MOMENTS OF INERTIA	DISTRIBUTED LOADS IN TONS THAT ONE FOOT WILL CARRY. COEFFICIENTS OF STRESS. SEE PAGE 1.		
				DPHT	WDTH	WEB THICK-NESS					MEAN TH. OF FLANGE	a	b
	G 6 ^a +	49	14x6	14x6.062	.497	.65	14.4						
Stock	G 6 ^a	46	» x »	»x6.0	.435	»	13.57	60.36	422.57	23.48	429.27	321.95	257.56
	G 6 ^a -	45	» x »	»x5.978	.413	»	13.22						

Lengths usually kept in stock 14 to 30 feet.

DORMAN, LONG & COMPANY, LIMITED, MIDDLESBOROUGH.

Distributed Loads in Tons for different spans, Coefficients *a b & c*

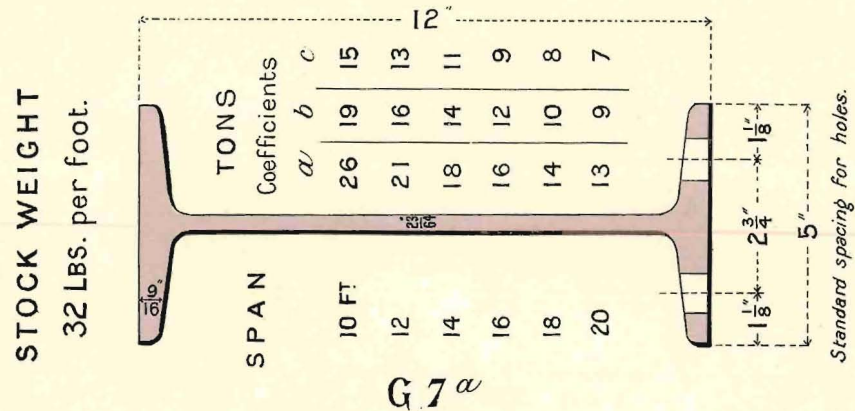

PLATE 66	N° OF SECTION	WEIGHT PER FOOT IN POUNDS	NORMAL SIZES IN INCHES	DIMENSIONS IN INCHES			SQUARE INCHES AREA	MOMENTS OF RESISTANCE IN SQ INCHES	VERTICAL OR GREATEST MOMENTS OF INERTIA	HORIZONTAL OR LEAST MOMENTS OF INERTIA	DISTRIBUTED LOADS IN TONS THAT ONE FOOT WILL CARRY. COEFFICIENTS OF STRESS. SEE PAGE I.			
				DPTH	WDTH	WEB THICK- NESS					MEAN TH. OF FLANGE	<i>a</i>	<i>b</i>	<i>c</i>
	G7 ^{a+}	36	12x5	12x5.098	.448	.56	10.58							
Stock	G7 ^a	32	„ x „	„x5.	.35	„	9.41	36.82	220.95	11.7	261.86	196.4	157.12	
	G7 ^{a-}	„	„ x „	„x„										

Lengths usually kept in stock 12 to 40 feet

DORMAN, LONG & COMPANY, LIMITED, MIDDLESBOROUGH.

Distributed Loads in Tons for different spans, Coefficients *a b & c*

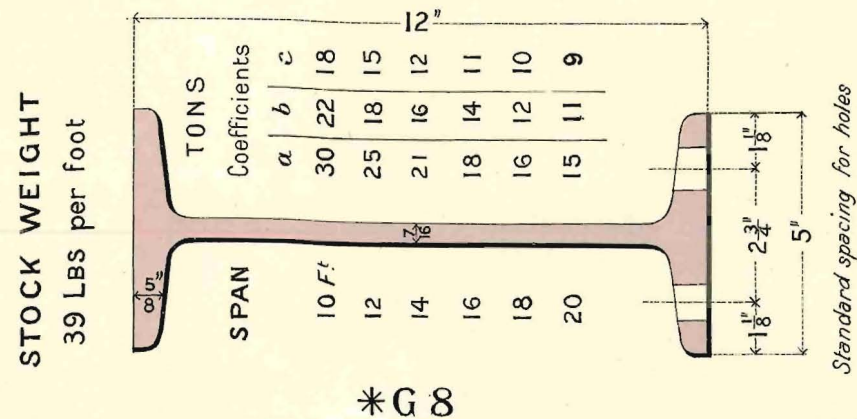

PLATE 67	N° OF SECTION	WEIGHT PER FOOT IN POUNDS	NORMAL SIZES IN INCHES	DIMENSIONS IN INCHES			SQUARE INCHES AREA	MOMENTS OF RESISTANCE IN SQ INCHES	VERTICAL OR GREATEST MOMENTS OF INERTIA	HORIZONTAL OR LEAST MOMENTS OF INERTIA	DISTRIBUTED LOADS IN TONS THAT ONE FOOT WILL CARRY. COEFFICIENTS OF STRESS. SEE PAGE I.			
				DPTH	WDTH	WEB THICK- NESS					MEAN TH. OF FLANGE	<i>a</i>	<i>b</i>	<i>c</i>
	G8+	41	12x5	12x5.054	.494	.65	12.05							
Stock	G8	39	„ x „	„x5.	.44	„	11.41	42.41	254.48	13.61	301.60	226.2	180.96	
	G8-	37	„ x „	„x4.956	.396	„	10.88							

Lengths usually kept in stock 12 to 40 feet.

DORMAN, LONG & COMPANY, LIMITED, MIDDLESBOROUGH.

Distributed Loads in Tons for different spans, Coefficients a b & c

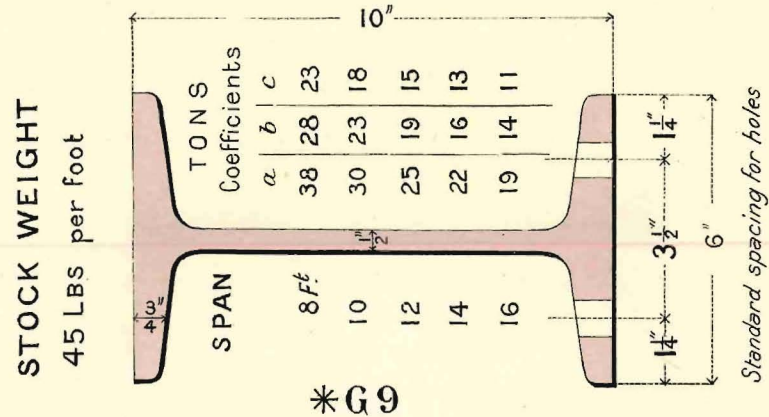

PLATE 68	N° OF SECTION	WEIGHT PER FOOT IN POUNDS	NORMAL SIZES IN INCHES	DIMENSIONS IN INCHES			SQUARE INCHES AREA	MOMENTS OF RESISTANCE IN SQ INCHES	VERTICAL OR GREATEST MOMENTS OF INERTIA	HORIZONTAL OR LEAST MOMENTS OF INERTIA	DISTRIBUTED LOADS IN TONS THAT ONE FOOT WILL CARRY. COEFFICIENTS OF STRESS. SEE PAGE I.			
				DPHT	WDTH	WEB THICK-NESS					MEAN TH. OF FLANGE	a	b	c
	G 9 +	48	10 x 6	10 x 6	0.88	0.577	0.74	14.11						
Stock	G 9	45	" x "	" x 6		0.489	"	13.23	43.19	215.97	26.71	307.15	230.36	184.26
	G 9 -	44	" x "	" x 5.971		0.46	"	12.94						

Lengths usually kept in stock 10 to 40 feet.

DORMAN, LONG & COMPANY, LIMITED, MIDDLESBOROUGH.

Distributed Loads in Tons for different spans, Coefficients a b & c

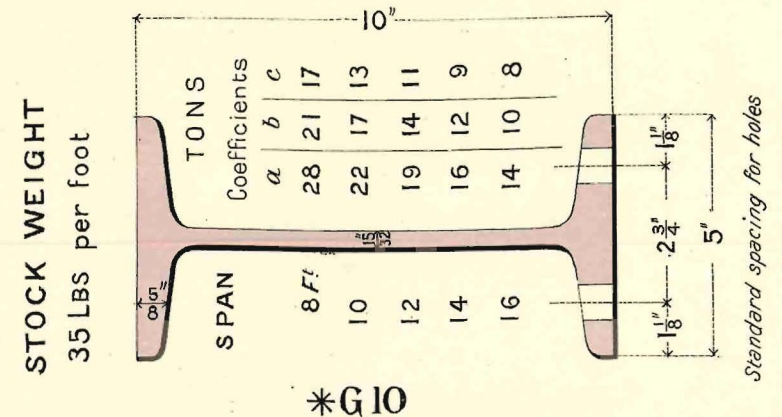
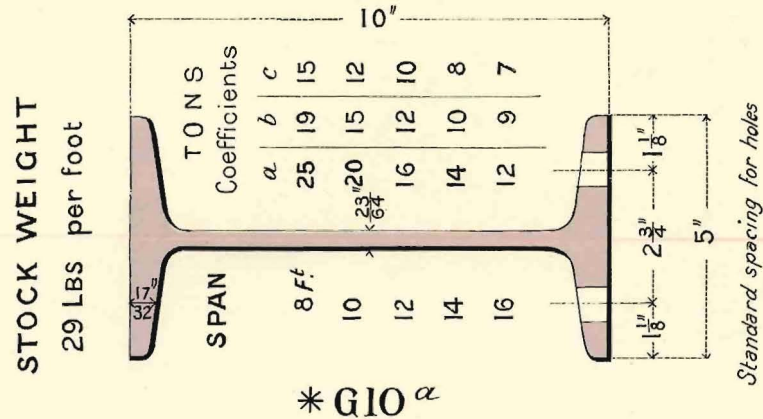

PLATE 69	N° OF SECTION	WEIGHT PER FOOT IN POUNDS	NORMAL SIZES IN INCHES	DIMENSIONS IN INCHES			SQUARE INCHES AREA	MOMENTS OF RESISTANCE IN SQ INCHES	VERTICAL OR GREATEST MOMENTS OF INERTIA	HORIZONTAL OR LEAST MOMENTS OF INERTIA	DISTRIBUTED LOADS IN TONS THAT ONE FOOT WILL CARRY. COEFFICIENTS OF STRESS. SEE PAGE I.			
				DPHT	WDTH	WEB THICK-NESS					MEAN TH. OF FLANGE	a	b	c
	G 10 +	37	10 x 5	10 x 5	0.59	0.539	0.6	10.87						
Stock	G 10	35	" x "	" x 5		0.48	"	10.28	31.99	159.97	12.58	227.52	170.64	136.51
	G 10 -	33	" x "	" x 4.942		0.422	"	9.7						

Lengths usually kept in stock 10 to 40 feet.

DORMAN, LONG & COMPANY, LIMITED, MIDDLESBOROUGH.

Distributed Loads in Tons for different spans, Coefficients a b & c



Standard spacing for holes

PLATE 70	N° OF SECTION	WEIGHT PER FOOT IN POUNDS	NORMAL SIZES IN INCHES	DIMENSIONS IN INCHES		SQUARE INCHES AREA	MOMENTS OF RESISTANCE IN SQ INCHES	VERTICAL OR GREATEST MOMENTS OF INERTIA	HORIZONTAL OR LEAST MOMENTS OF INERTIA	DISTRIBUTED LOADS IN TONS THAT ONE FOOT WILL CARRY. COEFFICIENTS OF STRESS. SEE PAGE I.			
				DEPTH	WIDTH					WEB THICKNESS	MEAN TH. OF FLANGE	a	b
	G10 ^{a+}	32	10×5	10×5.09	.44	.54	9.41						
Stock	G10 ^a	29	"×"	"×5.	.35	"	8.53	28.33	141.67	11.27	201.48	151.11	120.89
	G10 ^{a-}	28½	"×"	"×4.985	.335	"	8.38						

Lengths usually kept in stock 10 to 30 feet

DORMAN, LONG & COMPANY, LIMITED, MIDDLESBOROUGH.

Distributed Loads in Tons for different spans, Coefficients a b & c

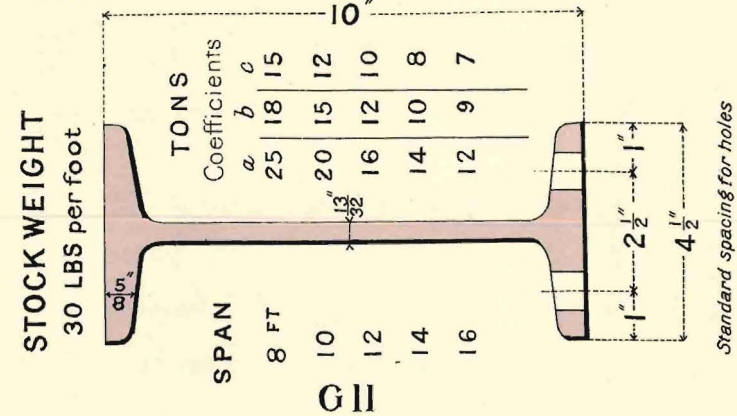

Standard spacing for holes

THIS WILL SOON BE OBSOLETE.

PLATE 71	N° OF SECTION	WEIGHT PER FOOT IN POUNDS	NORMAL SIZES IN INCHES	DIMENSIONS IN INCHES		SQUARE INCHES AREA	MOMENTS OF RESISTANCE IN SQ INCHES	VERTICAL OR GREATEST MOMENTS OF INERTIA	HORIZONTAL OR LEAST MOMENTS OF INERTIA	DISTRIBUTED LOADS IN TONS THAT ONE FOOT WILL CARRY. COEFFICIENTS OF STRESS. SEE PAGE I.			
				DEPTH	WIDTH					WEB THICKNESS	MEAN TH. OF FLANGE	a	b
	G11+	33	10×4½	10×4.588	.475	.6	9.71						
Stock	G11	30	"×"	"×4.5	.387	"	8.83	28.28	141.42	9.14	201.12	150.84	120.67
	G11-	29	"×"	"×4.47	.357	"	8.53						

Lengths usually kept in stock 10 to 40 feet

DORMAN, LONG & COMPANY, LIMITED, MIDDLESBOROUGH.

Distributed Loads in Tons for different spans, Coefficients a b & c.

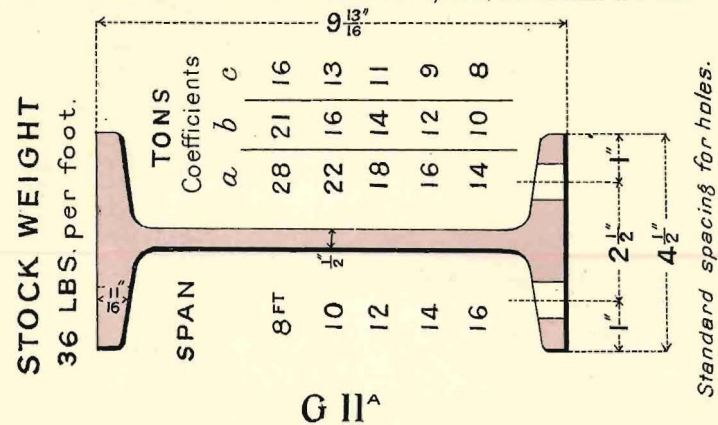

PLATE 72	N° OF SECTION	WEIGHT PER FOOT IN POUNDS	NORMAL SIZES IN INCHES	DIMENSIONS IN INCHES			SQUARE INCHES AREA	MOMENTS OF RESISTANCE IN SQ INCHES	VERTICAL OR GREATEST MOMENTS OF INERTIA	HORIZONTAL OR LEAST MOMENTS OF INERTIA	DISTRIBUTED LOADS IN TONS THAT ONE FOOT WILL CARRY. COEFFICIENTS OF STRESS. SEE PAGE 1.			
				DPHT	WDTH	WEB THICK- NESS					MEAN TH. OF FLANGE	a	b	c
	G11 ⁺	38	9 $\frac{13}{16}$ × 4 $\frac{1}{2}$	9 $\frac{13}{16}$	4.56	.576	.69	11.17						
Stock	G11 ^A	36	„ × „	„ × 4.5	.516	„	10.58	31.63	155.22	10.57	224.97	168.73	134.98	
	G11 ⁻	35	„ × „	„ × 4.47	.486	„	10.29							
Also	G11 ^B	21.5	9 $\frac{1}{4}$ × 3 $\frac{3}{4}$	9.25	3.75	.36	.438	6.45	17.52	81.0	3.88	124.54	93.40	74.72

Lengths usually kept in stock 15 to 40 feet.

DORMAN, LONG & COMPANY, LIMITED, MIDDLESBOROUGH.

Distributed Loads in Tons for different spans, Coefficients a b & c

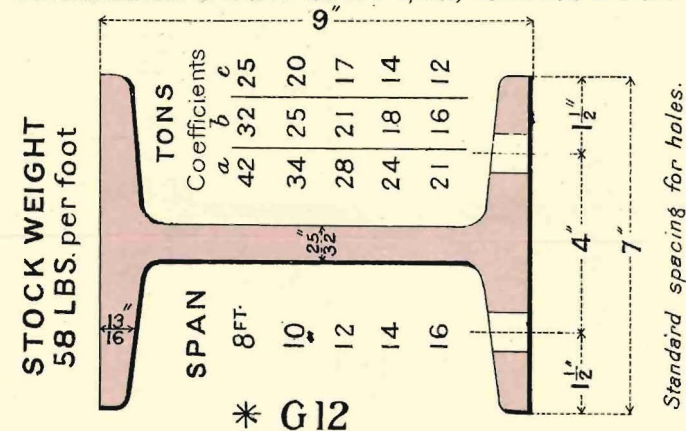
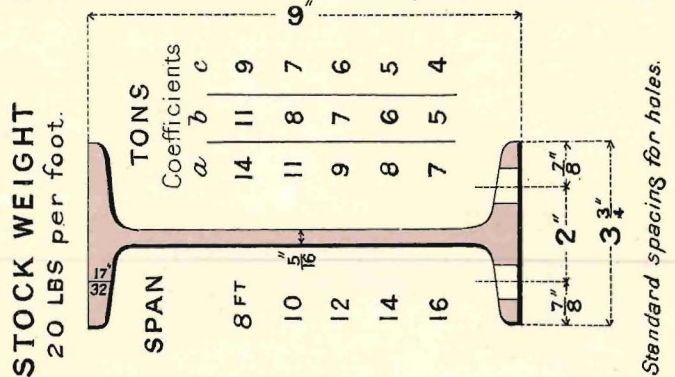

PLATE 73	N° OF SECTION	WEIGHT PER FOOT IN POUNDS	NORMAL SIZES IN INCHES	DIMENSIONS IN INCHES			SQUARE INCHES AREA	MOMENTS OF RESISTANCE IN SQ INCHES	VERTICAL OR GREATEST MOMENTS OF INERTIA	HORIZONTAL OR LEAST MOMENTS OF INERTIA	DISTRIBUTED LOADS IN TONS THAT ONE FOOT WILL CARRY. COEFFICIENTS OF STRESS. SEE PAGE 1.		
				DPHT	WDTH	WEB THICK- NESS					MEAN TH. OF FLANGE	a	b
	G12 ⁺	62	9 × 7	9 × 7	123.9	.81	18.2						
Stock	G12	58	„ × „	„ × 7	.777	„	17.05	48.18	216.81	46.59	342.61	256.96	205.56
	G12 ⁻	53.9	„ × „	„ × 6.866	.643	„	15.88						

Lengths usually kept in stock 15 to 40 feet

DORMAN, LONG & COMPANY, LIMITED, MIDDLESBOROUGH.

Distributed Loads in Tons for different spans, Coefficients a b & c



* G13

PLATE 74	N° OF SECTION	WEIGHT PER FOOT IN POUNDS	NORMAL SIZES IN INCHES	DIMENSIONS IN INCHES			SQUARE INCHES AREA	MOMENTS OF RESISTANCE IN SQ INCHES	VERTICAL OR GREATEST MOMENTS OF INERTIA	HORIZONTAL OR LEAST MOMENTS OF INERTIA	DISTRIBUTED LOADS IN TONS THAT ONE FOOT WILL CARRY. COEFFICIENTS OF STRESS. SEE PAGE I.			
				DPTH	WOTH	WEB THICK-NESS					MEAN TH. OF FLANGE	a	b	c
	G13+	22.5	9x3 3/4	9x3.835	.385	.45	6.62							
Stock	G13	20.	"x"	"x3.75	.3	"	5.88	16.66	75.02	3.962	118.54	88.91	71.12	
	G13-	19.5	"x"	"x3.732	.282	"	5.73							

Lengths usually kept in stock 10 to 40 feet.

DORMAN, LONG & COMPANY, LIMITED, MIDDLESBOROUGH.

Distributed Loads in Tons for different spans, Coefficients a b & c

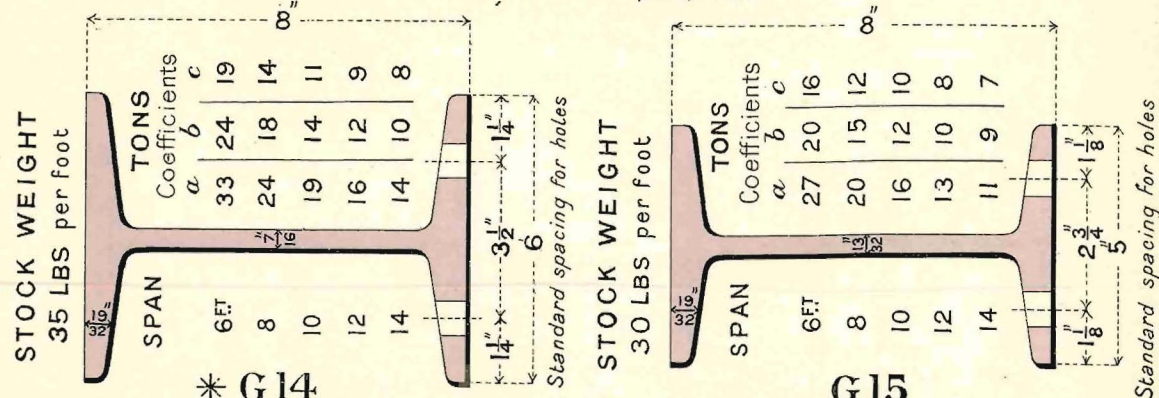

* G14

G15

PLATE 75	N° OF SECTION	WEIGHT PER FOOT IN POUNDS	NORMAL SIZES IN INCHES	DIMENSIONS IN INCHES			SQUARE INCHES AREA	MOMENTS OF RESISTANCE IN SQ INCHES	VERTICAL OR GREATEST MOMENTS OF INERTIA	HORIZONTAL OR LEAST MOMENTS OF INERTIA	DISTRIBUTED LOADS IN TONS THAT ONE FOOT WILL CARRY. COEFFICIENTS OF STRESS. SEE PAGE I.			
				DPTH	WOTH	WEB THICK-NESS					MEAN TH. OF FLANGE	a	b	c
	G14 +	38	8x6	8x6.11	.55	.61	11.18							
Stock	G14	35	"x"	"x6.	.44	"	10.3	27.89	111.59	22.005	198.37	148.78	119.03	
	G14 -	33	"x"	"x5.925	.365	"	9.7							
	G15 +	34	8x5	8x5.145	.545	.61	9.97							
Stock	G15	30	"x"	"x5.	.4	"	8.81	23.46	93.86	12.74	166.86	125.14	100.11	
	G15 -	29	"x"	"x4.962	.362	"	8.5							

Lengths usually kept in stock 10 to 40 feet.

DORMAN, LONG & COMPANY, LIMITED, MIDDLESBOROUGH.

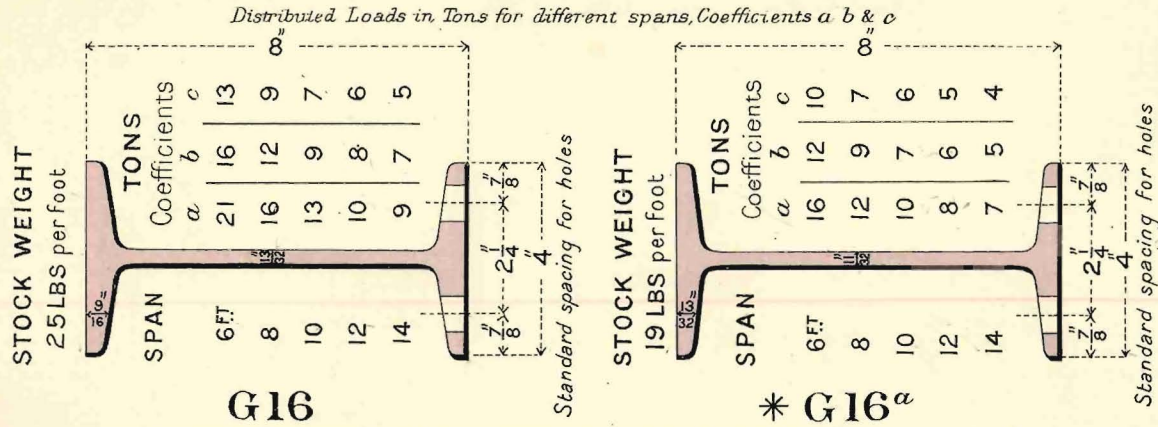

PLATE 76	N° OF SECTION	WEIGHT PER FOOT IN POUNDS	NORMAL SIZES IN INCHES	DIMENSIONS IN INCHES			SQUARE INCHES AREA	MOMENTS OF RESISTANCE IN SQ INCHES	VERTICAL OR GREATEST MOMENTS OF INERTIA	HORIZONTAL OR LEAST MOMENTS OF INERTIA	DISTRIBUTED LOADS IN TONS THAT ONE FOOT WILL CARRY. COEFFICIENTS OF STRESS. SEE PAGE 1.		
				DPHT	WTH	WEB THICK-NESS					MEAN TH. OF FLANGE	a	b
	G16 +	26	8 x 4	8 x 4.04	.45	.56	7.62						
Stock	G16	25	" x "	" x 4	.41	"	7.3	18.31	73.24	6.012	130.2	97.65	78.12
	G16 -	22	" x "	" 3.893	.303	"	6.45						
	G16 ^a +	22	8 x 4	8 x 4.111	.44	.4	6.45						
Stock	G16 ^a	19	" x "	" x 4	.329	"	5.562	14.12	56.48	4.287	100.41	75.3	60.24
	G16 ^a -	"	" x "	" "	"	"	" "						

Lengths usually kept in stock 10 to 40 feet.

DORMAN, LONG & COMPANY, LIMITED, MIDDLESBOROUGH.

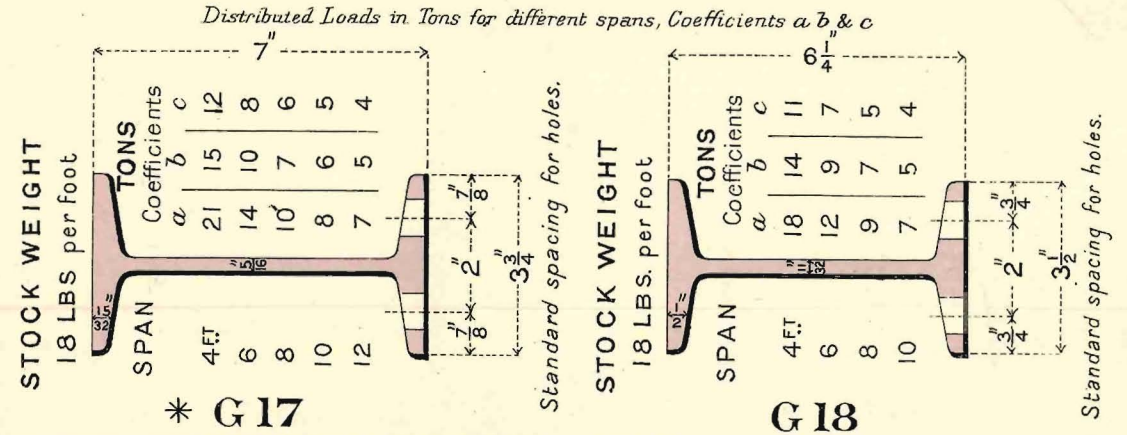

PLATE 77	N° OF SECTION	WEIGHT PER FOOT IN POUNDS	NORMAL SIZES IN INCHES	DIMENSIONS IN INCHES			SQUARE INCHES AREA	MOMENTS OF RESISTANCE IN SQ INCHES	VERTICAL OR GREATEST MOMENTS OF INERTIA	HORIZONTAL OR LEAST MOMENTS OF INERTIA	DISTRIBUTED LOADS IN TONS THAT ONE FOOT WILL CARRY. COEFFICIENTS OF STRESS. SEE PAGE 1.		
				DPHT	WTH	WEB THICK-NESS					MEAN TH. OF FLANGE	a	b
	G17 +	20	7 x 3 3/4	7 x 3.75	.396	.46	5.80						
Stock	G17	18	" x "	" 3.667	.313	"	5.28	11.99	41.99	3.788	85.31	63.98	51.18
	G17 -	"	" x "	" x " "	"	"	" "						
	G18 +	19	6 1/4 x 3 1/2	6.25 x 3.547	.386	.5	5.575						
Stock	G18	18	" x "	" x 3.5	.339	"	5.28	10.58	33.09	3.589	75.29	56.47	45.17
	G18 -	16	" x "	" x 3.406	.245	"	4.693						

Lengths usually kept in stock 10 to 40 feet.

DORMAN, LONG & COMPANY, LIMITED, MIDDLESBOROUGH.

Distributed Loads in Tons for different spans, Coefficients a b & c

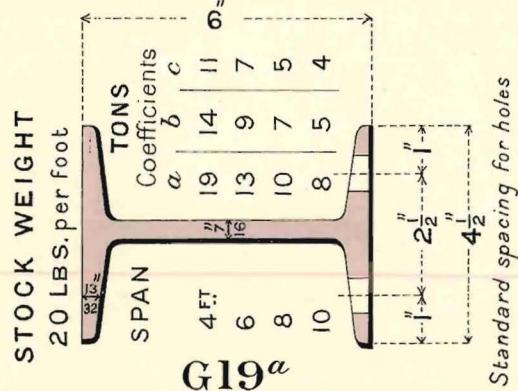
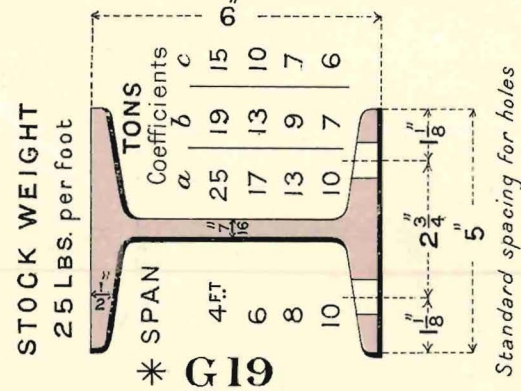

PLATE 78	N° OF SECTION	WEIGHT PER FOOT IN POUNDS	NORMAL SIZES IN INCHES	DIMENSIONS IN INCHES			SQUARE INCHES AREA	MOMENTS OF RESISTANCE IN SQ INCHES	VERTICAL OR GREATEST MOMENTS OF INERTIA	HORIZONTAL OR LEAST MOMENTS OF INERTIA	DISTRIBUTED LOADS IN TONS THAT ONE FOOT WILL CARRY. COEFFICIENTS OF STRESS. SEE PAGE I.			
				DEPTH	WIDTH	WEB THICKNESS					MEAN TH. OF FLANGE	a	b	c
	G19 +	26	6 x 5	6x5.053	.476	.52	7.62							
Stock	G19	25	" x "	"x5"	.423	"	7.3	14.48	43.46	10.86	103.01	77.26	61.81	
	G19 -	24.5	" x "	"x4.98	.403	"	7.18							
	G19 ^a +	22	6 x 4 1/2	6x4.598	.532	.4	6.45							
Stock	G19 ^a	20	" x "	"x4.5	.434	"	5.86	11.11	33.35	6.11	79.05	59.28	47.42	
	G19 ^a -	19	" x "	"x4.452	.386	"	5.575							

Lengths usually kept in stock 10 to 40 feet.

DORMAN, LONG & COMPANY, LIMITED, MIDDLESBOROUGH.

Distributed Loads in Tons for different spans, Coefficients a, b & c

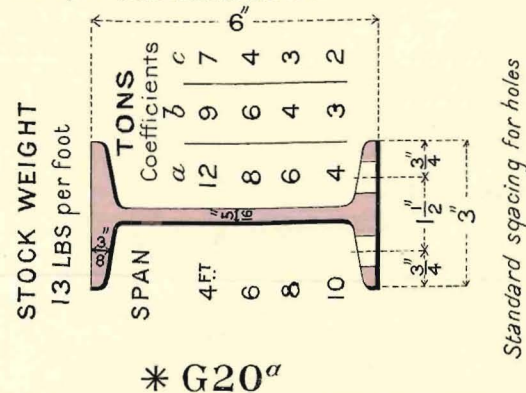
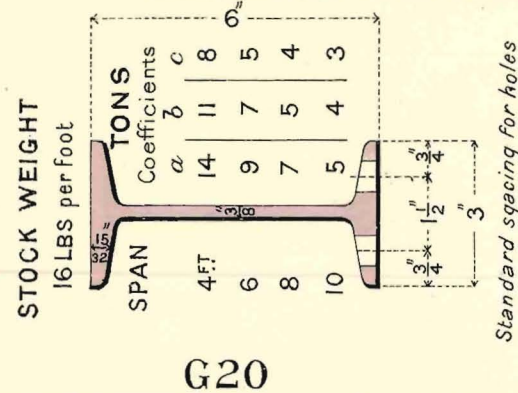
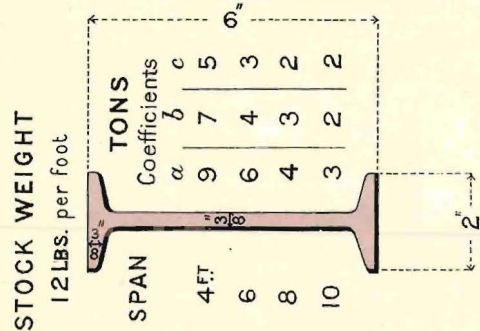

PLATE 79	N° OF SECTION	WEIGHT PER FOOT IN POUNDS	NORMAL SIZES IN INCHES	DIMENSIONS IN INCHES			SQUARE INCHES AREA	MOMENTS OF RESISTANCE IN SQ INCHES	VERTICAL OR GREATEST MOMENTS OF INERTIA	HORIZONTAL OR LEAST MOMENTS OF INERTIA	DISTRIBUTED LOADS IN TONS THAT ONE FOOT WILL CARRY. COEFFICIENTS OF STRESS. SEE PAGE I.		
				DEPTH	WIDTH	WEB THICKNESS					MEAN TH. OF FLANGE	a	b
	G20 +	18	6 x 3	6x3.098	.488	.45	5.28						
Stock	G20	16	" x "	"x3"	.39	"	4.693	8.38	25.14	2.05	59.59	44.69	35.75
	G20 -	15	" x "	"x2.951	.341	"	4.4						
	G20 ^a +	15	6 x 3	6x3.098	.42	.35	4.4						
Stock	G20 ^a	13	" x "	"x3"	.322	"	3.81	6.92	20.77	1.58	49.23	36.92	29.53
	G20 ^a -	"	" x "	"x"	"	"	"						

Lengths usually kept in stock 10 to 30 feet.

DORMAN, LONG & COMPANY, LIMITED, MIDDLESBOROUGH.

Distributed Loads in Tons for different spans, Coefficients a b & c



G21

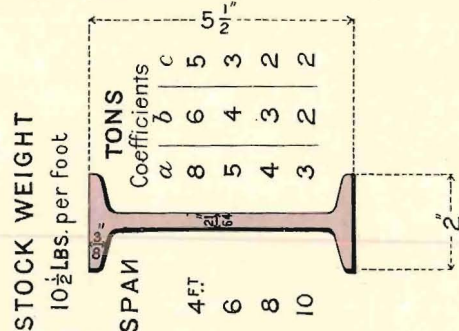

G22

PLATE	N° OF SECTION	WEIGHT PER FOOT IN POUNDS	NORMAL SIZES IN INCHES	DIMENSIONS IN INCHES			SQUARE INCHES AREA	MOMENTS OF RESISTANCE IN SQ INCHES	VERTICAL OR GREATEST MOMENTS OF INERTIA	HORIZONTAL OR LEAST MOMENTS OF INERTIA	DISTRIBUTED LOADS IN TONS THAT ONE FOOT WILL CARRY. COEFFICIENTS OF STRESS. SEE PAGE I.			
				DPHT	WDT	WEB THICK-NESS					MEAN TH. OF FLANGE	a	b	c
	G21 +	13	6 x 2	6x2.048	.429	.38	3.81							
Stock	G21	12	" x "	"x2.	.381	"	3.52	5.52	16.58	.53	39.3	29.47	23.58	
	G21 -	11	" x "	"x1.95	.331	"	3.22							
	G22 +	13	5 1/2 x 2	5.5x2.132	.461	.38	3.81							
Stock	G22	10.5	" x "	"x2.	.329	"	3.08	4.69	12.9	.52	33.35	25.01	20.01	
	G22 -	10	" x "	"x1.972	.301	"	2.93							

Lengths usually kept in stock 10 to 30 feet.

DORMAN, LONG & COMPANY, LIMITED, MIDDLESBOROUGH.

Distributed Loads in Tons for different spans, Coefficients a b & c

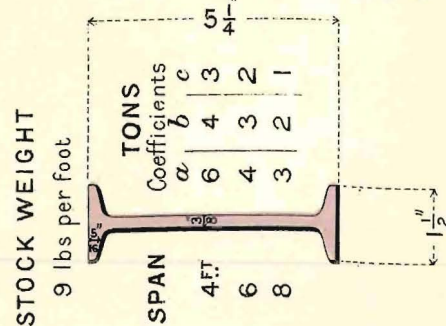

G22^a

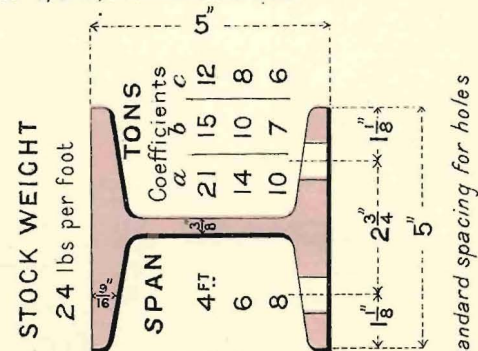

*G23

Standard spacing for holes

PLATE	N° OF SECTION	WEIGHT PER FOOT IN POUNDS	NORMAL SIZES IN INCHES	DIMENSIONS IN INCHES			SQUARE INCHES AREA	MOMENTS OF RESISTANCE IN SQ INCHES	VERTICAL OR GREATEST MOMENTS OF INERTIA	HORIZONTAL OR LEAST MOMENTS OF INERTIA	DISTRIBUTED LOADS IN TONS THAT ONE FOOT WILL CARRY. COEFFICIENTS OF STRESS. SEE PAGE I.			
				DPHT	WDT	WEB THICK-NESS					MEAN TH. OF FLANGE	a	b	c
	G22 ^a +	10	5 1/4 x 1 1/2	5.25x1.555	.423	.312	2.93							
Stock	G22 ^a	9	" x "	" 1.5	.368	"	2.64	3.34	8.77	.185	23.75	17.81	14.25	
	G22 ^a -	8	" x "	" 1.442	.310	"	2.347							
	G23 +	26	5 x 5	5x5.116	.487	.56	7.62							
Stock	G23	24	" x "	"x5.	.371	"	7.04	11.82	29.55	11.68	84.05	63.04	50.43	
	G23 -	23	" x "	"x4.94	.311	"	6.74							

Lengths usually kept in stock 10 to 30 feet for G22^a

" " " " " 10 " 40 " " G23

DORMAN, LONG & COMPANY, LIMITED, MIDDLESBOROUGH.

Distributed Loads in Tons for different spans, Coefficients a b & c

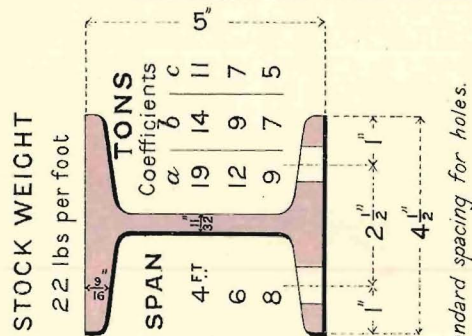

G24

Standard spacing for holes.

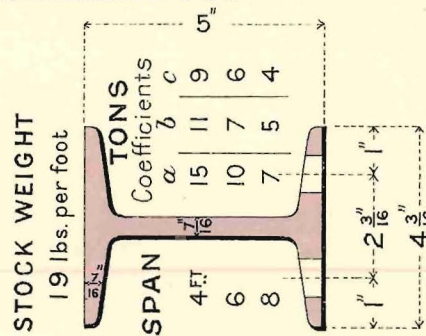

*G24^a

Standard spacing for holes.

PLATE 82	N ^o OF SECTION	WEIGHT PER FOOT IN POUNDS	NORMAL SIZES IN INCHES	DIMENSIONS IN INCHES		SQUARE INCHES AREA	MOMENTS OF RESISTANCE IN SQ INCHES	VERTICAL OR GREATEST MOMENTS OF INERTIA	HORIZONTAL OR LEAST MOMENTS OF INERTIA	DISTRIBUTED LOADS IN TONS THAT ONE FOOT WILL CARRY. COEFFICIENTS OF STRESS. SEE PAGE I.			
				DPHT	WTH					WEB THICK-NESS	MEAN TH. OF FLANGE	a	b
	G24+	24	5 x 4 1/2	5 x 4.518	.46	.57	7.04						
Stock	G24	22	" x "	" x 4.5	.342	"	6.45	10.77	26.94	8.66	76.62	57.47	45.97
	G24-	21.5	" x "	" x 4.47	.312	"	6.3						
	G24 ^a +	20	5 x 4 3/16	5 x 4.1932	.497	.45	5.86						
Stock	G24 ^a	19	" x "	" x 4.1875	.44	"	5.575	8.83	22.09	5.52	62.83	47.12	37.7
	G24 ^a -	18	" x "	" x 4.1285	.381	"	5.28						

Lengths usually kept in stock, 10 to 40 feet.

DORMAN, LONG & COMPANY, LIMITED, MIDDLESBOROUGH.

Distributed Loads in Tons for different spans, Coefficients a b & c

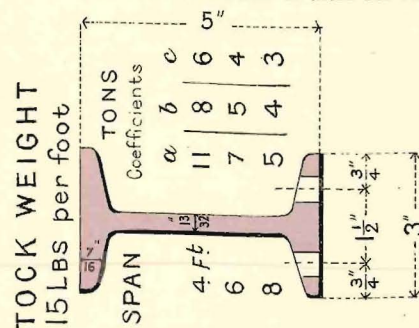

G25

Standard spacing for holes.

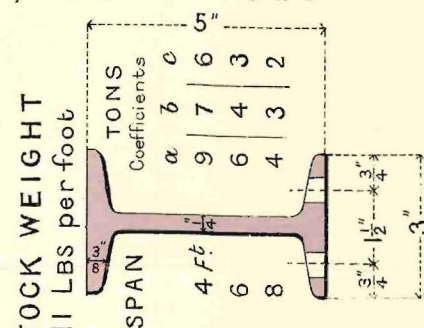

*G25^a

Standard spacing for holes.

PLATE 83	N ^o OF SECTION	WEIGHT PER FOOT IN POUNDS	NORMAL SIZES IN INCHES	DIMENSIONS IN INCHES			SQUARE INCHES AREA	MOMENTS OF RESISTANCE IN SQ INCHES	VERTICAL OR GREATEST MOMENTS OF INERTIA	HORIZONTAL OR LEAST MOMENTS OF INERTIA	DISTRIBUTED LOADS IN TONS THAT ONE FOOT WILL CARRY. COEFFICIENTS OF STRESS. SEE PAGE I.		
				DPHT	WTH	WEB THICK-NESS					MEAN TH. OF FLANGE	a	b
	G25+	16	5 x 3	5 x 3.058	.458	.44	4.693						
Stock	G25	15	" x "	" x 3.0	.4	"	4.40	6.43	16.09	2.00	45.76	34.32	27.46
	G25-	13	" x "	" x 2.882	.282	"	3.81						
	G25 ^a +	12.5	5 x 3	5 x 3.09	.328	.38	3.738						
Stock	G25 ^a	11	" x "	" x 3.0	.23	"	3.25	5.46	13.65	1.714	38.82	29.12	23.29
	G25 ^a -	10.5	" x "	" x 2.94	.187	"	3.015						

Lengths usually kept in stock 10 to 30 feet.

DORMAN, LONG & COMPANY, LIMITED, MIDDLESBOROUGH

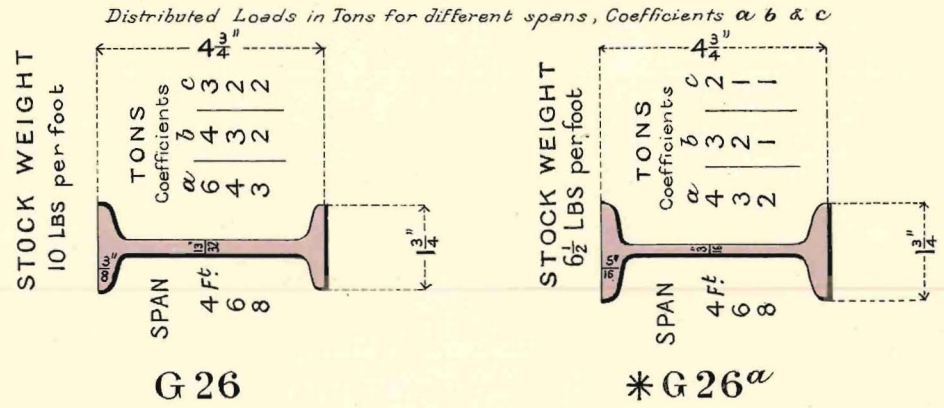

PLATE 84	N° OF SECTION	WEIGHT PER FOOT IN POUNDS	NORMAL SIZES IN INCHES	DIMENSIONS, IN INCHES			SQUARE INCHES AREA	MOMENTS OF RESISTANCE IN SQ INCHES	VERTICAL OR GREATEST MOMENTS OF INERTIA	HORIZONTAL OR LEAST MOMENTS OF INERTIA	DISTRIBUTED LOADS IN TONS THAT ONE FOOT WILL CARRY. COEFFICIENTS OF STRESS. SEE PAGE I.			
				DPHT	WDTH	WEB THICK- NESS					MEAN TH. OF FLANGE	a	b	c
	G26+	11	4 3/4 x 1 3/4	475	1.811	.461	.38	3.22						
Stock	G26	10	" x "	" x 1.75	.4	"	2.93	3.57	8.48	.36	25.38	19.04	15.23	
	G26-	9	" x "	" x 1.689	.339	"	2.64							
	G26 ^a +	9	4 3/4 x 1 3/4	475	1.811	.359	.3125	2.61						
Stock	G26	6.5	" x "	" x 1.75	.1875	"	1.90	2.73	6.5	.27	19.4	14.5	11.6	
	G26 ^a -	"	" x "	" x "	"	"	"							

Lengths usually kept in stock 10 to 30 feet

DORMAN, LONG & COMPANY, LIMITED, MIDDLESBOROUGH.

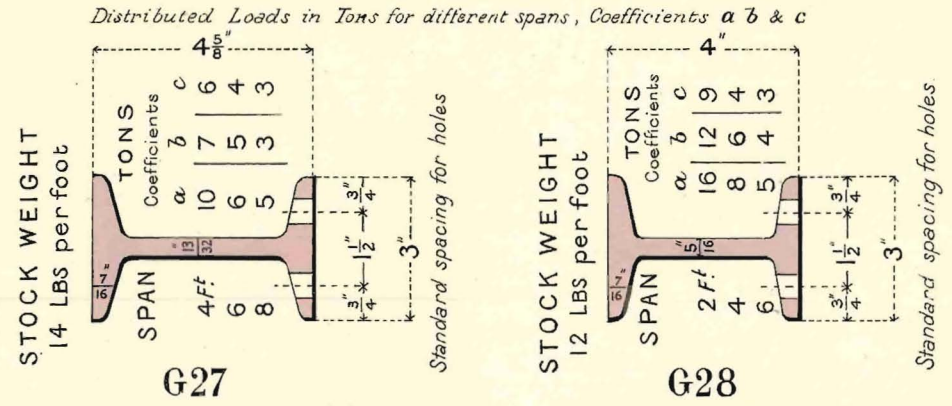

PLATE 85	N° OF SECTION	WEIGHT PER FOOT IN POUNDS	NORMAL SIZES IN INCHES	DIMENSIONS IN INCHES			SQUARE INCHES AREA	MOMENTS OF RESISTANCE IN SQ INCHES	VERTICAL OR GREATEST MOMENTS OF INERTIA	HORIZONTAL OR LEAST MOMENTS OF INERTIA	DISTRIBUTED LOADS IN TONS THAT ONE FOOT WILL CARRY. COEFFICIENTS OF STRESS. SEE PAGE I.			
				DPHT	WDTH	WEB THICK- NESS					MEAN TH. OF FLANGE	a	b	c
	G27+	16	4 5/8 x 3	4.625	3.128	.528	.43	4.693						
Stock	G27	14	" x "	" x 3	.4	"	4.10	5.68	13.17	1.95	40.49	30.37	24.29	
	G27-	12	" x "	" x 2.874	.274	"	3.52							
	G28+	15	4 x 3	4 x 3.22	.519	.43	4.40							
Stock	G28	12	" x "	" x 3	.299	"	3.52	4.51	9.03	1.94	32.10	24.08	19.26	
	G28-	11.5	" x "	" x 2.962	.261	"	3.37							
	G28 ^a +	10.5	4 x 3	4 x 3.075	.3	.34								
Stock	G28 ^a	9.5	" x "	" x 3	.225	"	2.79	3.769	7.538	1.53	26.8	20.1	16.06	
	G28 ^a -	9	" x "	" x 2.96	.185	"								

DORMAN, LONG & COMPANY, LIMITED, MIDDLESBOROUGH.

Distributed Loads in Tons for different spans, Coefficients a b & c

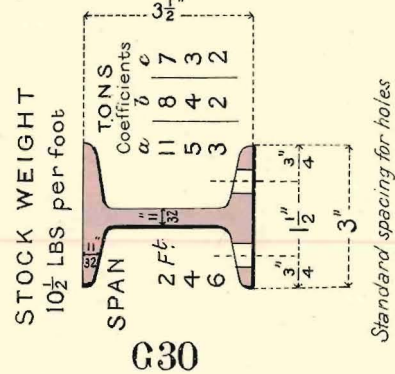
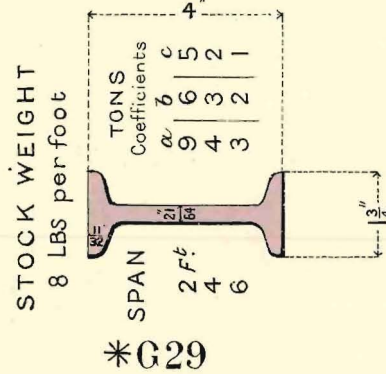

PLATE	N° OF SECTION	WEIGHT PER FOOT IN POUNDS	NORMAL SIZES IN INCHES	DIMENSIONS IN INCHES			SQUARE INCHES AREA	MOMENTS OF RESISTANCE IN SQ INCHES	VERTICAL OR GREATEST MOMENTS OF INERTIA	HORIZONTAL OR LEAST MOMENTS OF INERTIA	DISTRIBUTED LOADS IN TONS THAT ONE FOOT WILL CARRY. COEFFICIENTS OF STRESS. SEE PAGE 1.			
				DPHT	WTDH	MEAN TH. OF FLANGE					a	b	c	
86														
	G29 +	10	4 x 1 3/4	4x1.895	.476	.36	2.93	2.58	5.16	.33	18.34	13.76	11.0	
Stock	G29	8	" x "	"x1.75	.331	"	2.347							
	G29 -	7	" x "	"x1.675	.256	"	2.05	3.35	5.87	1.58	23.85	17.88	14.31	
Stock	G30 +	12	3 1/2 x 3	35x3.125	.475	.35	3.52							
	G30	10.5	" x "	" x 3"	.35	"	3.08							
Stock	G30 -	9	" x "	" x 2.874	.224	"	2.64							

Lengths usually kept in stock 10 to 30 feet

DORMAN, LONG & COMPANY, LIMITED, MIDDLESBOROUGH.

Distributed Loads in Tons for different spans, Coefficients a b & c

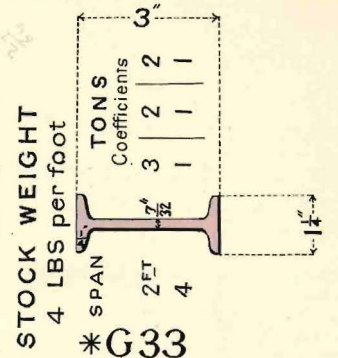
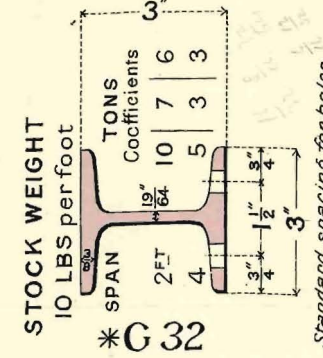
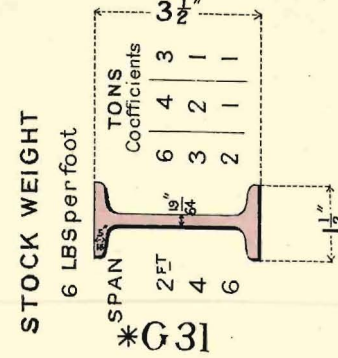
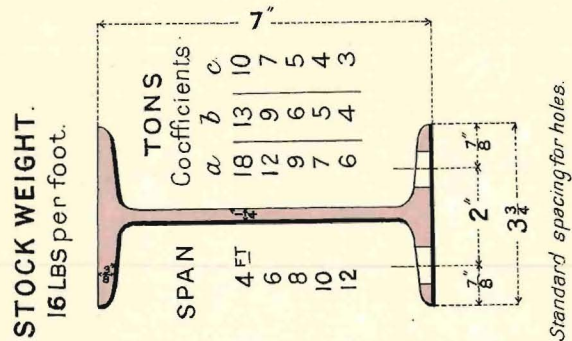

PLATE	N° OF SECTION	WEIGHT PER FOOT IN POUNDS	NORMAL SIZES IN INCHES	DIMENSIONS IN INCHES			SQUARE INCHES AREA	MOMENTS OF RESISTANCE IN SQ INCHES	VERTICAL OR GREATEST MOMENTS OF INERTIA	HORIZONTAL OR LEAST MOMENTS OF INERTIA	DISTRIBUTED LOADS IN TONS THAT ONE FOOT WILL CARRY. COEFFICIENTS OF STRESS. SEE PAGE 1.		
				DPHT	WTDH	MEAN TH. OF FLANGE					a	b	c
87													
	G31 +	7	3 1/2 x 1 1/2	3.5x1.582	.378	.3	2.05	1.66	2.91	.17	11.82	8.86	7.09
Stock	G31	6	" x "	"x1.5	.296	"	1.76						
	G31 -	5	" x "	"x1.414	.21	"	1.46	2.8	4.21	1.71	19.95	14.96	11.97
Stock	G32 +	12	3 x 3	3 x 3.196	.486	.38	3.52						
	G32 -	9	" x "	"x2.903	.193	"	2.64						
Stock	G32 +	5	3 x 1 1/4	3 x 1.346	.314	.25	1.46	.98	1.47	.08	6.96	5.22	4.18
Stock	G33	4	" x "	"x1.25	.218	"	1.17						
	G33 -	3.5	" x "	"x1.192	.168	"	1.02						

Lengths usually kept in stock 10 to 30 feet.

DORMAN, LONG & COMPANY, LIMITED, MIDDLESBOROUGH.

Distributed Loads in Tons for different spans, Coefficients a b & c.



G17^A

Standard spacing for holes.

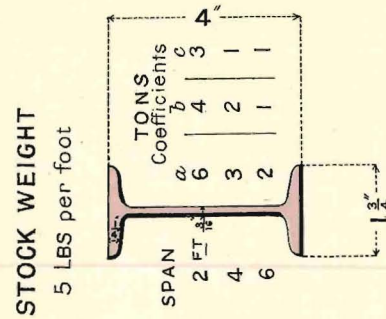

G29^A

PLATE 88	N° OF SECTION	WEIGHT PER FOOT IN POUNDS	NORMAL SIZES IN INCHES	DIMENSIONS IN INCHES		SQUARE INCHES AREA	MOMENTS OF RESISTANCE IN SQ INCHES	VERTICAL OR GREATEST MOMENTS OF INERTIA	HORIZONTAL OR LEAST MOMENTS OF INERTIA	DISTRIBUTED LOADS IN TONS THAT ONE FOOT WILL CARRY. COEFFICIENTS OF STRESS. SEE PAGE I.			
				DEPTH	WIDTH					WEB THICKNESS	MEAN TH. OF FLANGE	a	b
	G17 ^A +	17	7 x 3 3/4	7 x 3	706	·315	·375	5·0					
Stock	G17 ^A -	16	" x "	" x 3	75	·25	"	4·7	10·28	35·98	3·299	73·10	54·82 43·86
	G29 ^A +	6	4 x 1 3/4	4 x 1	781	·24	·24	1·76					
Stock	G29 ^A -	5	" x "	" 1	75	·18	"	1·47	1·814	3·628	·214	12·899	9·67 7·73

*Lengths usually kept in stock 10 to 40 feet for G17^A
 " " " " " 10 " 30 " " G29^A*

DORMAN, LONG & COMPANY, LIMITED, MIDDLESBOROUGH.

2 L^s 4" x 4" x 1/2" x 14' long.

STANDARD ANGLE BRACKETS.

2 L^s 4" x 4" x 1/2" x 12' long.

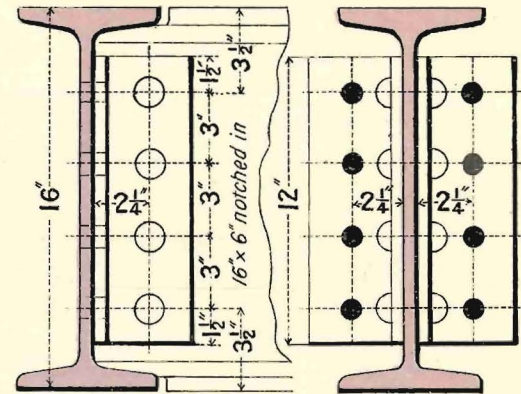
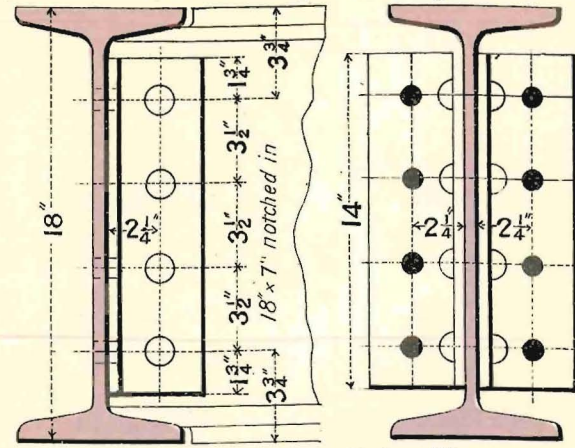

All Holes 1 3/8"

All Rivets 3/4"

2 L^s 4" x 4" x 1/2" x 12' long

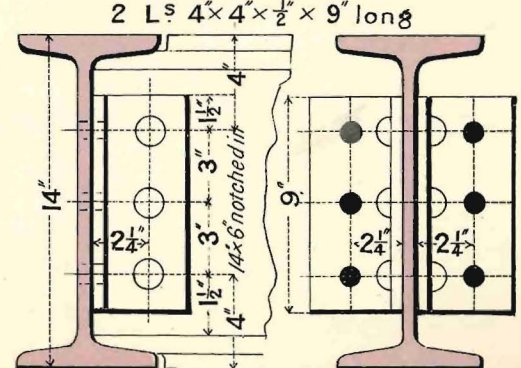
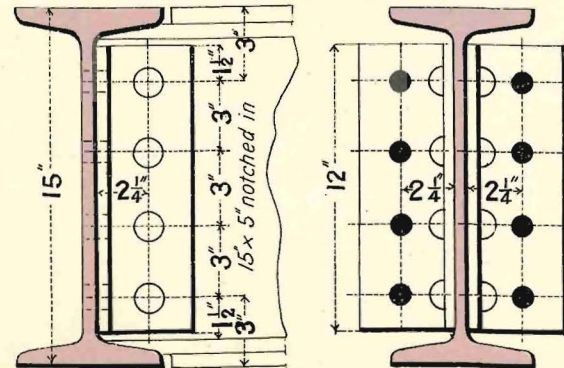

DORMAN, LONG & COMPANY, LIMITED, MIDDLESBOROUGH.

STANDARD ANGLE BRACKETS.

2 L^s 4x4x½x9" long.

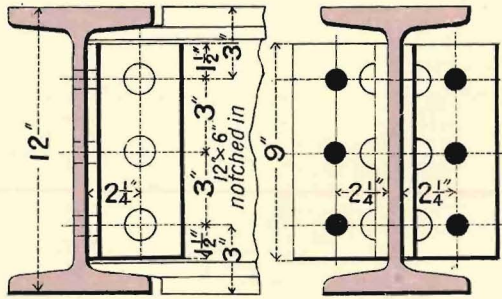

2 L^s 4x4x½x7" long.

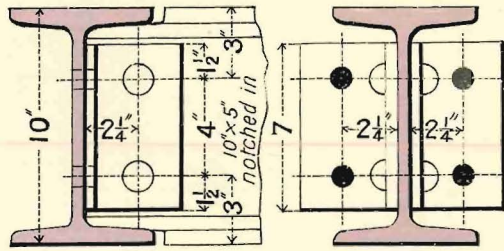

All Holes ⅜".

All Rivets ¼".

2 L^s 4x4x½x6" long.

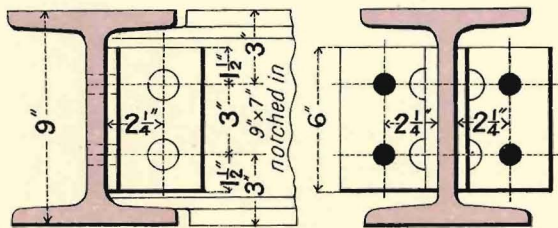

2 L^s 3½x3½x½x5½" long.

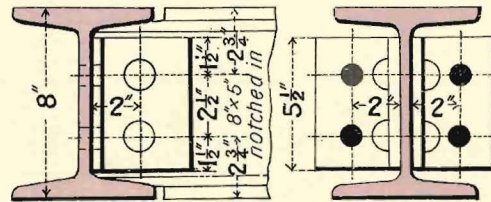

DORMAN, LONG & COMPANY, LIMITED, MIDDLESBOROUGH.

STANDARD ANGLE BRACKETS.

2 L^s 3½x3½x½x5" long.

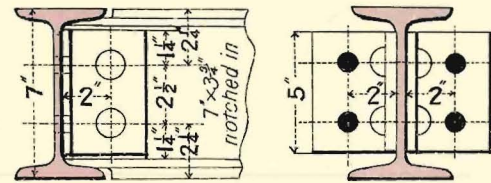

2 L^s 6x4x½x3½" long.

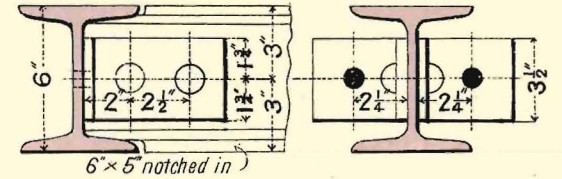

2 L^s 6x4x½x3" long.

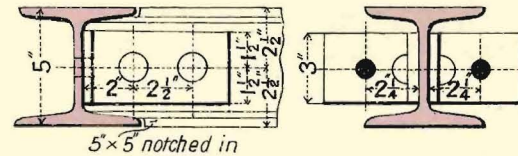

2 L^s 6x3½x½x2½" long.

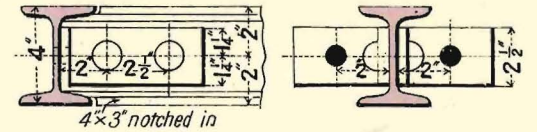

2 L^s 6x3½x½x1¾" long.

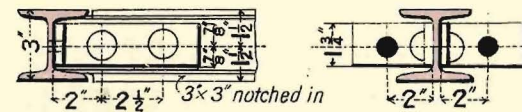

All Holes ⅜".

All Rivets ⅝".

DORMAN, LONG & COMPANY, LIMITED, MIDDLESBOROUGH.

STANDARD JOINT PLATES FOR GIRDERS.

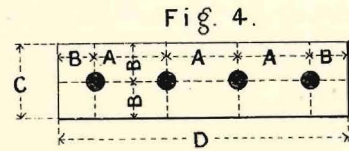
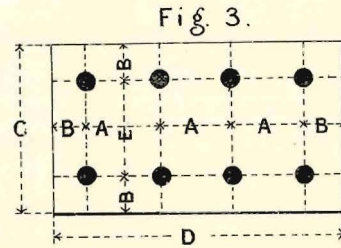
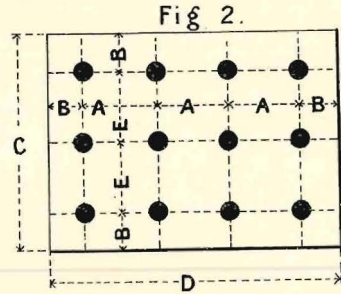
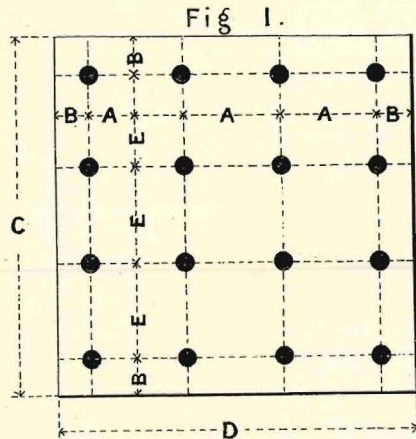

Reference

Fig	A	B	C	D	E	For Girders	20 and	18 inches deep
1	4"	1 1/2"	15"	15"	4"	"	"	"
2	3"	1 1/2"	12"	12"	3"	"	"	"
3	3"	1 1/2"	9"	12"	3"	"	"	"
4	3"	1 1/2"	7"	12"	4"	"	"	"
4	3"	1"	3"	12"	-	"	"	"
4	3"	1"	2"	12"	-	"	"	"

DORMAN, LONG & COMPANY, LIMITED, MIDDLESBOROUGH.

Distributed Loads in Tons for different spans, Coefficients *b* & *c*

Compound Girders.

STOCK SECTIONS

144 LBS per foot

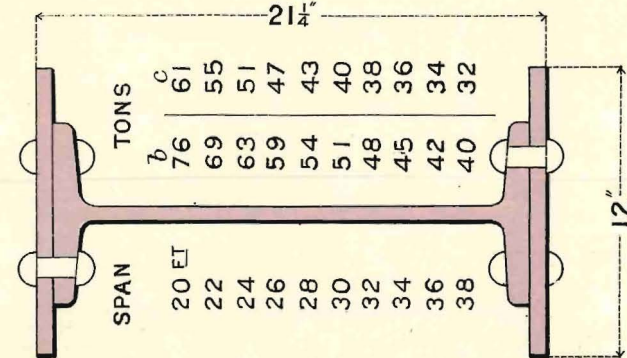

G I C I

PLATE	Nº OF SECTION	WEIGHT PER FOOT IN POUNDS	SIZES IN INCHES DPTH WDT	COMPOUNDED OF	AREA IN SQUARE INCHES	MOMENTS OF RESISTANCE IN SQUARE INCHES	VERTICAL OR GREATEST MOMENTS OF INERTIA	DISTRIBUTED LOADS IN TONS THAT ONE FOOT WILL CARRY. COEFFICIENTS OF STRESS. SEE PAGE I.	
								<i>b</i>	<i>c</i>
G I C I		144	21 1/4" x 12"	1 G I and 2 5/8" plates	37.95	287.51	3054.88	1533.43	1226.72

DORMAN, LONG & COMPANY, LIMITED, MIDDLESBOROUGH.

Distributed Loads in Tons for different spans, Coefficients *b* & *c*

Compound Girders.
STOCK SECTIONS
260 LBS per foot

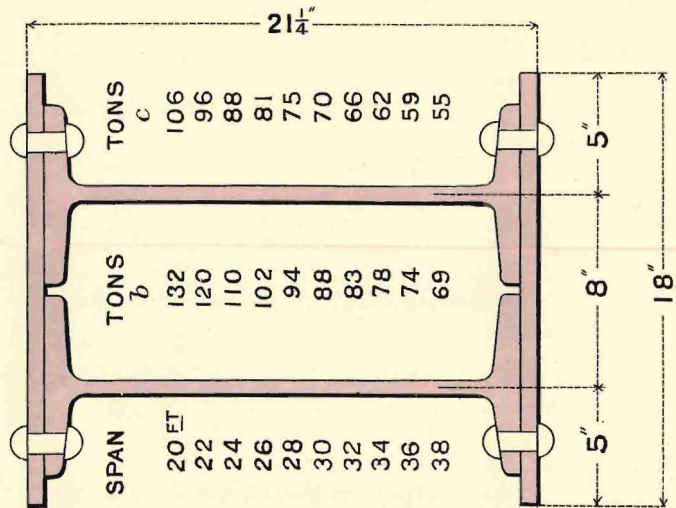

G1C2

PLATE 94	Nº OF SECTION	WEIGHT PER FOOT IN POUNDS	SIZES IN INCHES DPTH WDT	COMPOUNDED OF	AREA IN SQUARE INCHES	MOMENTS OF RESISTANCE IN SQUARE INCHES	VERTICAL OR GREATEST MOMENTS OF INERTIA	DISTRIBUTED LOADS IN TONS THAT ONE FOOT WILL CARRY. SEE PAGE I.	
								<i>b</i>	<i>c</i>
	G1C2	260	2 1/4 x 18	2G1 and 2-5/8 plates	68.4	497.69	5287.98	2654.36	2123.48

DORMAN, LONG & COMPANY, LIMITED, MIDDLESBOROUGH.

Distributed Loads in Tons for different spans, Coefficients *b* & *c*

Compound Girders.
STOCK SECTIONS
377 LBS per foot

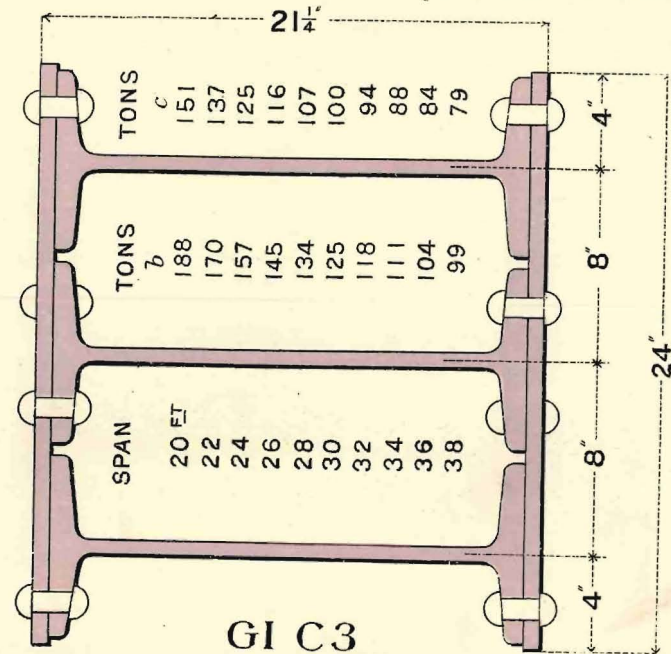

G1C3

PLATE 95	Nº OF SECTION	WEIGHT PER FOOT IN POUNDS	SIZES IN INCHES DPTH WDT	COMPOUNDED OF	AREA IN SQUARE INCHES	MOMENTS OF RESISTANCE IN SQUARE INCHES	VERTICAL OR GREATEST MOMENTS OF INERTIA	DISTRIBUTED LOADS IN TONS THAT ONE FOOT WILL CARRY. SEE PAGE I.	
								<i>b</i>	<i>c</i>
	G1C3	377	2 1/4 x 24	3G1 and 2-5/8 plates	98.85	707.86	7521.08	3775.29	3020.23

DORMAN, LONG & COMPANY, LIMITED, MIDDLESBOROUGH.

Distributed Loads in Tons for different spans, Coefficients *b* & *c*

Compound Girders.

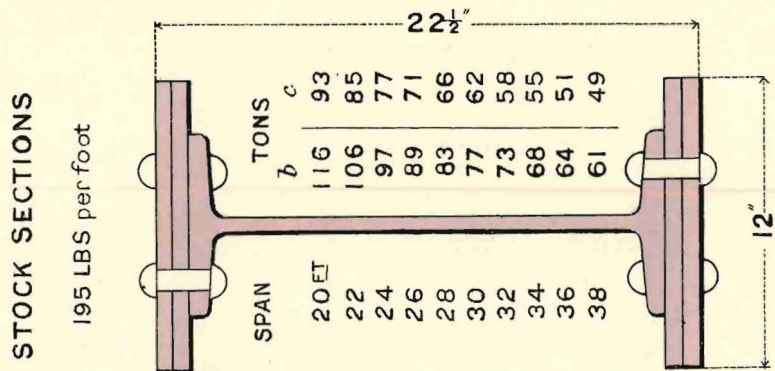

G1 C4

PLATE 96	N ^o OF SECTION	WEIGHT PER FOOT IN POUNDS	SIZES IN INCHES DPTH WDT	COMPOUNDED OF	AREA IN SQUARE INCHES	MOMENTS OF RESISTANCE IN SQUARE INCHES	VERTICAL OR GREATEST MOMENTS OF INERTIA	DISTRIBUTED LOADS IN TONS THAT ONE FOOT WILL CARRY. COEFFICIENTS OF STRESS. SEE PAGE I.	
								<i>b</i>	<i>c</i>
								G1 C4	195

DORMAN, LONG & COMPANY, LIMITED, MIDDLESBOROUGH.

Distributed Loads in Tons for different spans, Coefficients *b* & *c*

Compound Girders.

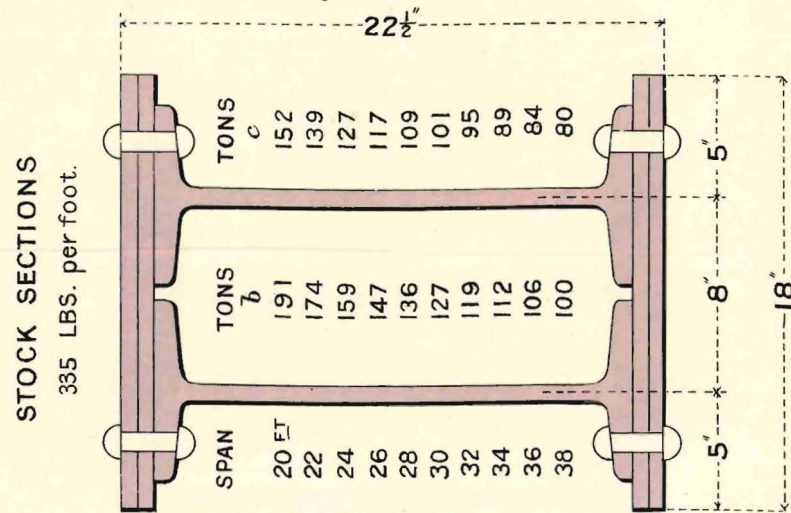

G1 C5

PLATE 97	N ^o OF SECTION	WEIGHT PER FOOT IN POUNDS	SIZES IN INCHES DPTH WDT	COMPOUNDED OF	AREA IN SQUARE INCHES	MOMENTS OF RESISTANCE IN SQUARE INCHES	VERTICAL OR GREATEST MOMENTS OF INERTIA	DISTRIBUTED LOADS IN TONS THAT ONE FOOT WILL CARRY. COEFFICIENTS OF STRESS. SEE PAGE I.	
								<i>b</i>	<i>c</i>
								G1 C5	335

DORMAN, LONG & COMPANY, LIMITED, MIDDLESBOROUGH.

Distributed Loads in Tons for different spans, Coefficients *b* & *c*

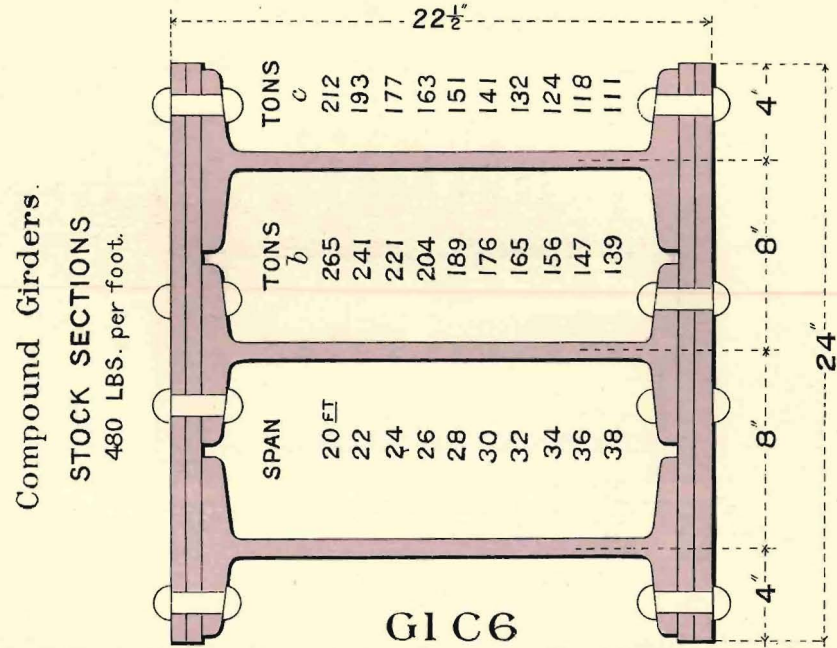

G1C6

PLATE 98	N ^o OF SECTION	WEIGHT PER FOOT IN POUNDS	SIZES IN INCHES DPTH WDT	COMPOUNDED OF	AREA IN SQUARE INCHES	MOMENTS OF RESISTANCE IN SQUARE INCHES	VERTICAL OR GREATEST MOMENTS OF INERTIA	DISTRIBUTED LOADS IN TONS THAT ONE FOOT WILL CARRY. COEFFICIENTS OF STRESS. SEE PAGE I.	
								<i>b</i>	<i>c</i>
	G1C6	480	22½ × 24	3 G1 and 4 5/8" plates	125.1	994.97	11193.48	5306.54	4245.23

DORMAN, LONG & COMPANY, LIMITED, MIDDLESBOROUGH.

Compound Girders.

Distributed Loads in Tons for different spans, Coefficients *b* & *c*

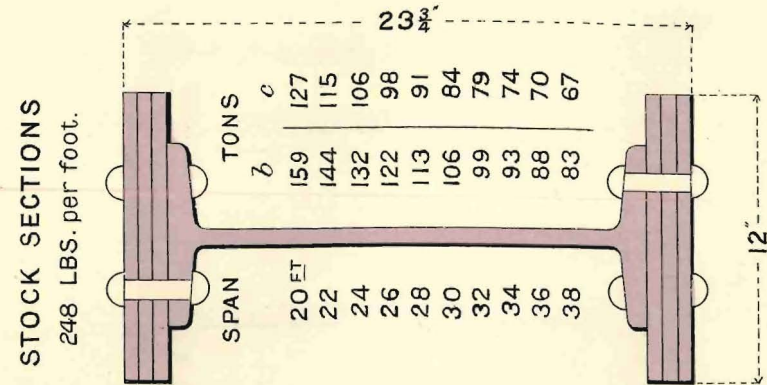

G1C7

PLATE 99	N ^o OF SECTION	WEIGHT PER FOOT IN POUNDS	SIZES IN INCHES DPTH WDT	COMPOUNDED OF	AREA IN SQUARE INCHES	MOMENTS OF RESISTANCE IN SQUARE INCHES	VERTICAL OR GREATEST MOMENTS OF INERTIA	DISTRIBUTED LOADS IN TONS THAT ONE FOOT WILL CARRY. COEFFICIENTS OF STRESS. SEE PAGE I.	
								<i>b</i>	<i>c</i>
	G1C7	248	23¾ × 12	1 G1 and 6 5/8" plates	65.45	596.89	7088.1	3183.43	2546.74

DORMAN, LONG & COMPANY, LIMITED, MIDDLESBOROUGH.

Distributed Loads in Tons for different spans, Coefficients *b* & *c*

Compound Girders.

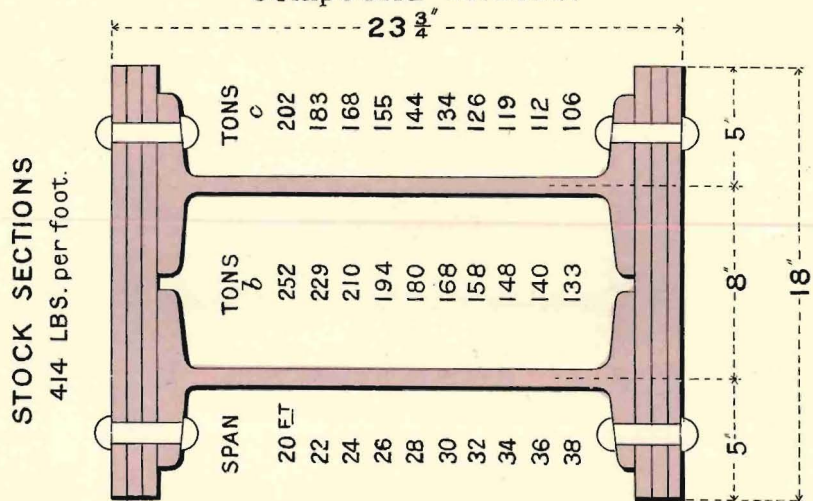

GIC 8

PLATE 100	Nº OF SECTION	WEIGHT PER FOOT IN POUNDS	SIZES IN INCHES DPTH WDT	COMPOUNDED OF	AREA IN SQUARE INCHES	MOMENTS OF RESISTANCE IN SQUARE INCHES	VERTICAL OR GREATEST MOMENTS OF INERTIA	DISTRIBUTED LOADS IN TONS THAT ONE FOOT WILL CARRY. COEFFICIENTS OF STRESS. SEE PAGE I.	
								<i>b</i>	<i>c</i>
	GIC 8	414	23 3/4 x 18	2GI and 6 5/8 plates	108.4	947.58	11252.51	5054.36	4043.48

DORMAN, LONG & COMPANY, LIMITED, MIDDLESBOROUGH.

Distributed Loads in Tons for different spans, Coefficients *b* & *c*

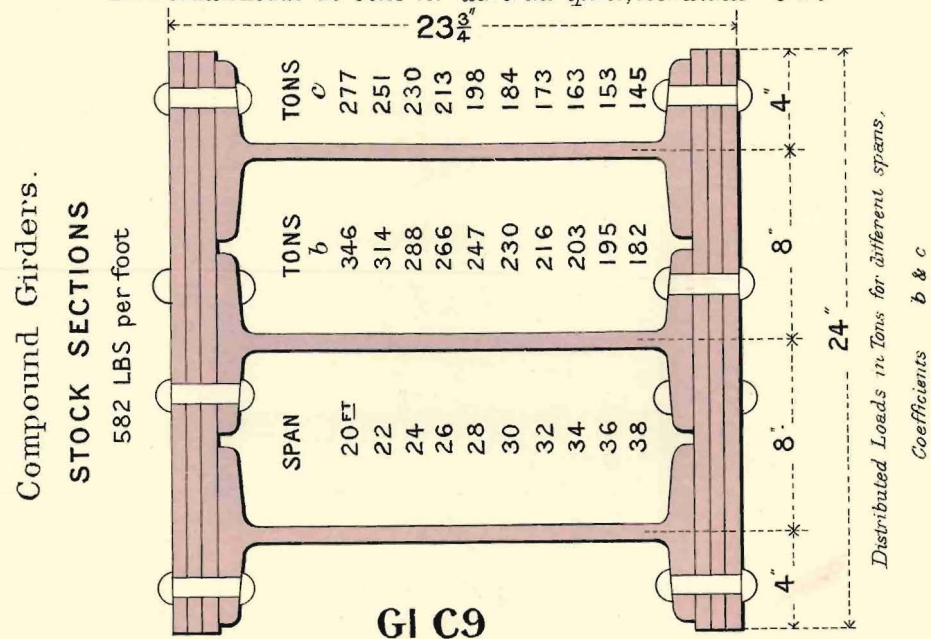

GIC 9

PLATE 101	Nº OF SECTION	WEIGHT PER FOOT IN POUNDS	SIZES IN INCHES DPTH WDT	COMPOUNDED OF	AREA IN SQUARE INCHES	MOMENTS OF RESISTANCE IN SQUARE INCHES	VERTICAL OR GREATEST MOMENTS OF INERTIA	DISTRIBUTED LOADS IN TONS THAT ONE FOOT WILL CARRY. COEFFICIENTS OF STRESS. SEE PAGE I.	
								<i>b</i>	<i>c</i>
	GI C9	582	23 3/4 x 24	3GI and 6 5/8 plates	151.35	1298.49	15419.59	6925.29	5540.23

DORMAN, LONG & COMPANY, LIMITED, MIDDLESBOROUGH.

Compound Girders.

Distributed Loads in Tons for different spans, Coefficients *b* & *c*

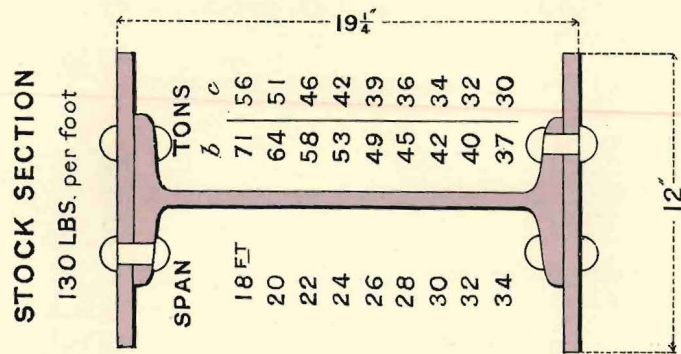

G2 C1

PLATE 102	Nº OF SECTION	WEIGHT PER FOOT IN POUNDS	SIZES IN INCHES DPTH WTDH	COMPOUNDED OF	AREA IN SQUARE INCHES	MOMENTS OF RESISTANCE IN SQUARE INCHES	VERTICAL OR GREATEST MOMENTS OF INERTIA	DISTRIBUTED LOADS IN TONS THAT ONE FOOT WILL CARRY. COEFFICIENTS OF STRESS. SEE PAGE I.	
								<i>b</i>	<i>c</i>
	G2C1	130	19 1/4 x 12	1G2 and 2-5/8" plates	33.896	239.81	2308.2	1279.19	1023.35

DORMAN, LONG & COMPANY, LIMITED, MIDDLESBOROUGH.

Compound Girders.

Distributed Loads in Tons for different spans, Coefficients *b* & *c*

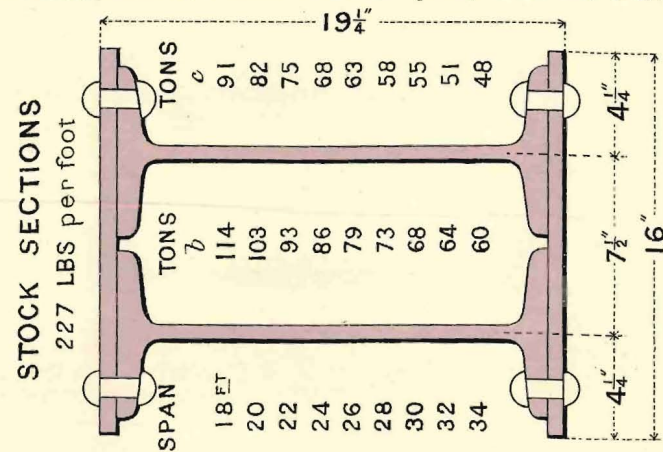

G2 C2

PLATE 103	Nº OF SECTION	WEIGHT PER FOOT IN POUNDS	SIZES IN INCHES DPTH WTDH	COMPOUNDED OF	AREA IN SQUARE INCHES	MOMENTS OF RESISTANCE IN SQUARE INCHES	VERTICAL OR GREATEST MOMENTS OF INERTIA	DISTRIBUTED LOADS IN TONS THAT ONE FOOT WILL CARRY. COEFFICIENTS OF STRESS. SEE PAGE I.	
								<i>b</i>	<i>c</i>
	G2C2	227	19 1/4 x 16	2G2 and 2-5/8" plates	57.79	386.57	3720.76	2061.72	1649.37

DORMAN, LONG & COMPANY, LIMITED, MIDDLESBOROUGH.

Distributed Loads in Tons for different spans, Coefficients *b* & *c*

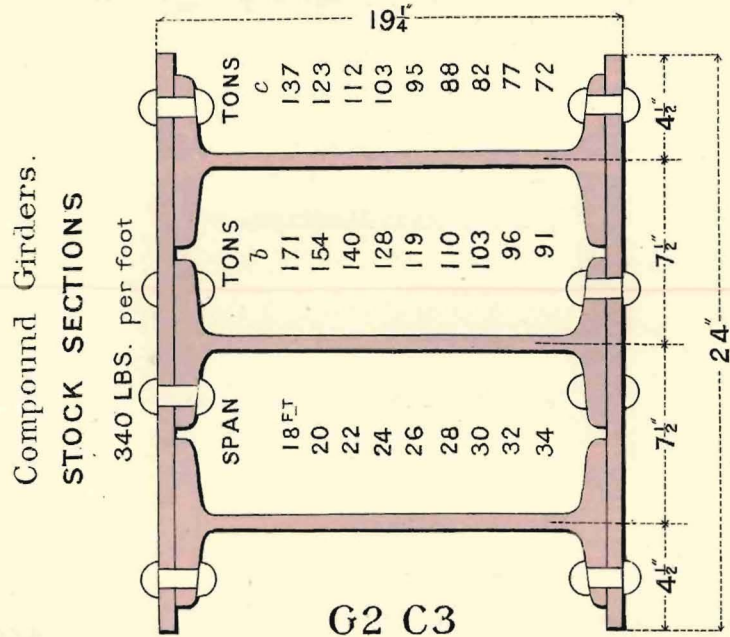

G2 C3

PLATE	N ^o OF SECTION	WEIGHT PER FOOT IN POUNDS	SIZES IN INCHES DPTH WTH	COMPOUNDED OF	AREA IN SQUARE INCHES	MOMENTS OF RESISTANCE IN SQUARE INCHES	VERTICAL OR GREATEST MOMENTS OF INERTIA	DISTRIBUTED LOADS IN TONS THAT ONE FOOT WILL CARRY. SEE PAGE I.	
								<i>b</i>	<i>c</i>
104	G2 C3	340	19 1/4" x 24"	3 G2 and 2 5/8" plates	86.68	579.85	5581.15	3092.59	2474.07

DORMAN, LONG & COMPANY, LIMITED, MIDDLESBOROUGH.

Distributed Loads in Tons for different spans, Coefficients *b* & *c*

Compound Girders.

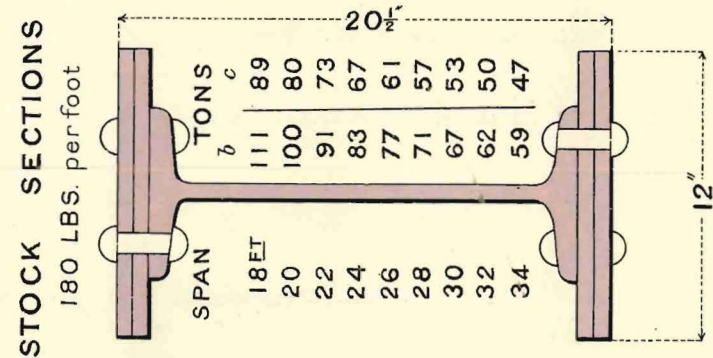

G2 C4

PLATE	N ^o OF SECTION	WEIGHT PER FOOT IN POUNDS	SIZES IN INCHES DPTH WTH	COMPOUNDED OF	AREA IN SQUARE INCHES	MOMENTS OF RESISTANCE IN SQUARE INCHES	VERTICAL OR GREATEST MOMENTS OF INERTIA	DISTRIBUTED LOADS IN TONS THAT ONE FOOT WILL CARRY. SEE PAGE I.	
								<i>b</i>	<i>c</i>
105	G2 C4	180	20 1/2" x 12"	1 G2 and 4 5/8" plates	47.64	376.48	3859.0	2007.94	1606.35

DORMAN, LONG & COMPANY, LIMITED, MIDDLESBOROUGH.

Compound Girders.

Distributed Loads in Tons for different spans, Coefficients *b* & *c*

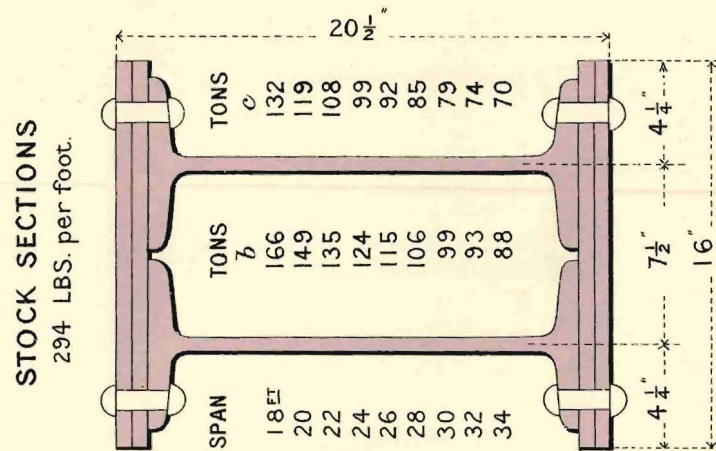

G2 C5

PLATE 106	Nº OF SECTION	WEIGHT PER FOOT IN POUNDS	SIZES IN INCHES DPTH WDTH	COMPOUNDED OF	AREA IN SQUARE INCHES	MOMENTS OF RESISTANCE IN SQUARE INCHES	VERTICAL OR GREATEST MOMENTS OF INERTIA	DISTRIBUTED LOADS IN TONS THAT ONE FOOT WILL CARRY. COEFFICIENTS OF STRESS. SEE PAGE I.	
								<i>b</i>	<i>c</i>
	G2 C5	294	20 1/2 x 16	2 G2 and 4 1/8 plates	75.29	560.47	5744.9	2989.22	2391.37

DORMAN, LONG & COMPANY, LIMITED, MIDDLESBOROUGH.

Distributed Loads in Tons for different spans, Coefficients *b* & *c*

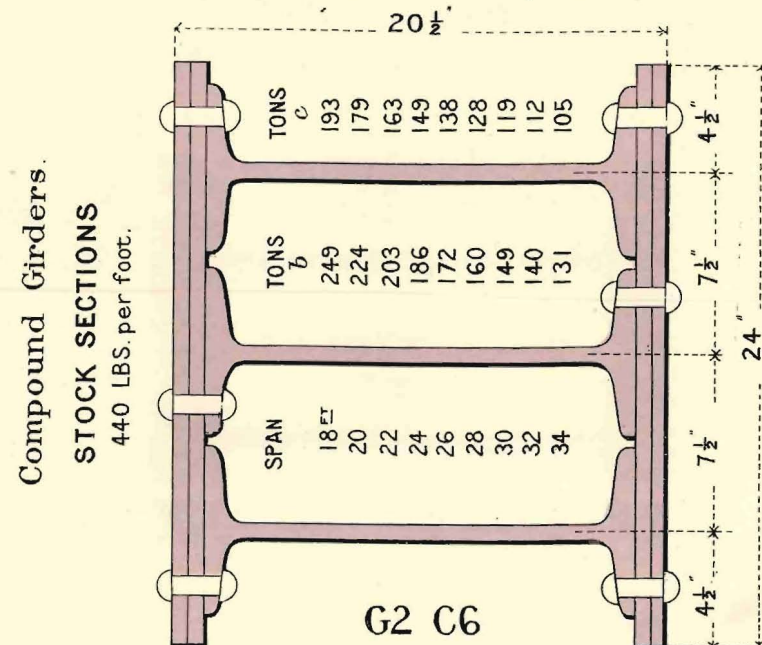

G2 C6

PLATE 107	Nº OF SECTION	WEIGHT PER FOOT IN POUNDS	SIZES IN INCHES DPTH WDTH	COMPOUNDED OF	AREA IN SQUARE INCHES	MOMENTS OF RESISTANCE IN SQUARE INCHES	VERTICAL OR GREATEST MOMENTS OF INERTIA	DISTRIBUTED LOADS IN TONS THAT ONE FOOT WILL CARRY. COEFFICIENTS OF STRESS. SEE PAGE I.	
								<i>b</i>	<i>c</i>
	G2 C6	440	20 1/2 x 24	3 G2 and 4 5/8 plates	112.93	840.72	8617.38	4483.84	3587.07

DORMAN, LONG & COMPANY, LIMITED, MIDDLESBOROUGH.

Distributed Loads in Tons for different spans, Coefficients *b* & *c*

Compound Girders.

STOCK SECTIONS
360 LBS per foot.

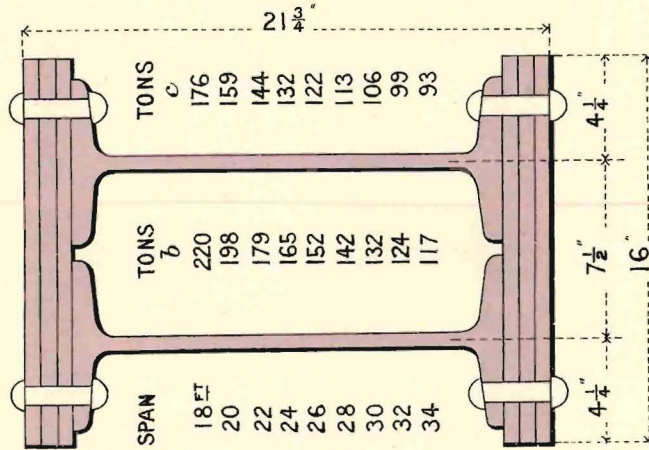

G2 C7

PLATE 108	Nº OF SECTION	WEIGHT PER FOOT IN POUNDS	SIZES IN INCHES DPTH WDTH	COMPOUNDED OF	AREA IN SQUARE INCHES	MOMENTS OF RESISTANCE IN SQUARE INCHES	VERTICAL OR GREATEST MOMENTS OF INERTIA	DISTRIBUTED LOADS IN TONS THAT ONE FOOT WILL CARRY. COEFFICIENTS OF STRESS. SEE PAGE I.	
								<i>b</i>	<i>c</i>
	G2 C7	360	21 3/4 x 16	2G2 and 6 5/8" plates	92.79	745.32	8105.39	3975.06	3180.04

DORMAN, LONG & COMPANY, LIMITED, MIDDLESBOROUGH.

Distributed Loads in Tons for different spans, Coefficients *b* & *c*

Compound Girders.

STOCK SECTIONS
540 LBS per foot.

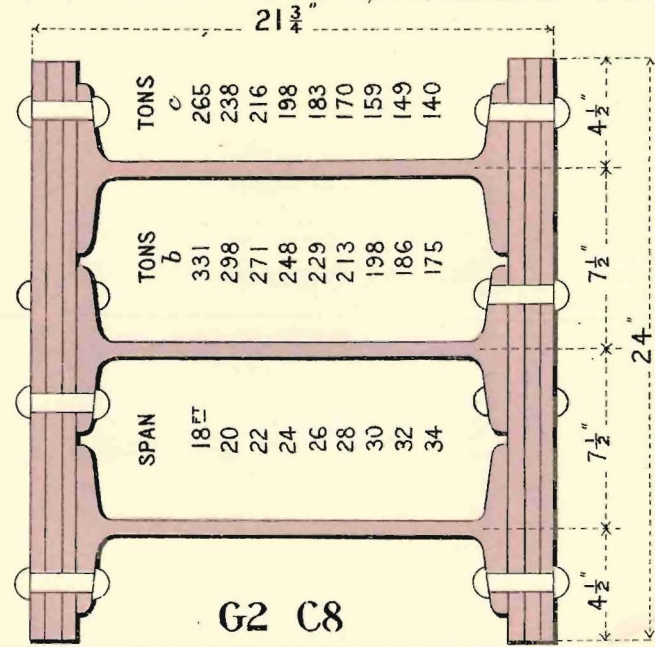

G2 C8

PLATE 109	Nº OF SECTION	WEIGHT PER FOOT IN POUNDS	SIZES IN INCHES DPTH WDTH	COMPOUNDED OF	AREA IN SQUARE INCHES	MOMENTS OF RESISTANCE IN SQUARE INCHES	VERTICAL OR GREATEST MOMENTS OF INERTIA	DISTRIBUTED LOADS IN TONS THAT ONE FOOT WILL CARRY. COEFFICIENTS OF STRESS. SEE PAGE I.	
								<i>b</i>	<i>c</i>
	G2 C8	540	21 3/4 x 24	3G2 and 6 5/8" plates	139.18	1117.98	12158.09	5962.59	4770.07

DORMAN, LONG & COMPANY, LIMITED, MIDDLESBOROUGH.

Compound Girders.

Distributed Loads in Tons for different spans, Coefficients b & c

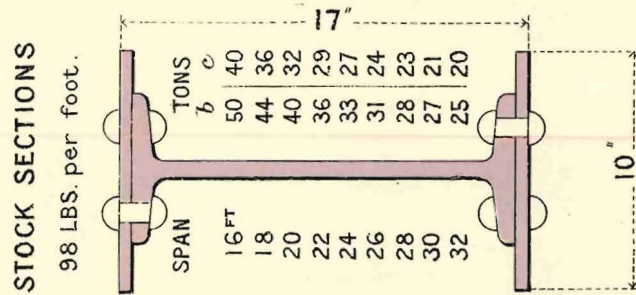

G3 C1

PLATE	Nº OF SECTION	WEIGHT PER FOOT IN POUNDS	SIZES IN INCHES DPTH WDT	COMPOUNDED OF	AREA IN SQUARE INCHES	MOMENTS OF RESISTANCE IN SQUARE INCHES	VERTICAL OR GREATEST MOMENTS OF INERTIA	DISTRIBUTED LOADS IN TONS THAT ONE FOOT WILL CARRY. SEE PAGE I.	
								b	c
110	G3 C1	98	17 x 10	1G3 and 2-1/2 plates	25.53	151.66	1289.16	808.89	647.11

DORMAN, LONG & COMPANY, LIMITED, MIDDLESBOROUGH.

Compound Girders.

Distributed Loads in Tons for different spans, Coefficients b & c

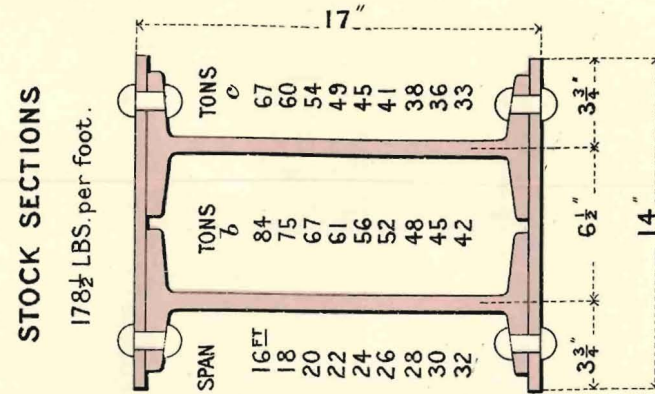

G3 C2

PLATE	Nº OF SECTION	WEIGHT PER FOOT IN POUNDS	SIZES IN INCHES DPTH WDT	COMPOUNDED OF	AREA IN SQUARE INCHES	MOMENTS OF RESISTANCE IN SQUARE INCHES	VERTICAL OR GREATEST MOMENTS OF INERTIA	DISTRIBUTED LOADS IN TONS THAT ONE FOOT WILL CARRY. SEE PAGE I.	
								b	c
111	G3 C2	178.5	17 x 14	2G3 and 2-1/2 plates	45.06	253.83	2157.58	1353.78	1083.02

DORMAN, LONG & COMPANY, LIMITED, MIDDLESBOROUGH.

Compound Girders.

Distributed Loads in Tons for different spans, Coefficients *b* & *c*

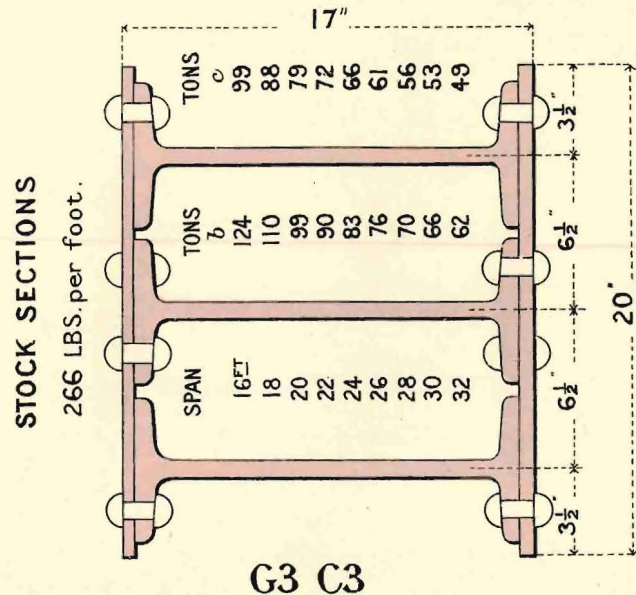

PLATE	N ^o OF SECTION	WEIGHT PER FOOT IN POUNDS	SIZES IN INCHES DPTH WDT	COMPOUNDED OF	AREA IN SQUARE INCHES	MOMENTS OF RESISTANCE IN SQUARE INCHES	VERTICAL OR GREATEST MOMENTS OF INERTIA	DISTRIBUTED LOADS IN TONS THAT ONE FOOT WILL CARRY. COEFFICIENTS OF STRESS. SEE PAGE I.	
								<i>b</i>	<i>c</i>
112	G3 C3	266	17 × 20	3G3 and 2½ plates	66.59	372 37	3165.18	1986.67	1589.33

DORMAN, LONG & COMPANY, LIMITED, MIDDLESBOROUGH.

Compound Girders.

Distributed Loads in Tons for different spans, Coefficients *b* & *c*

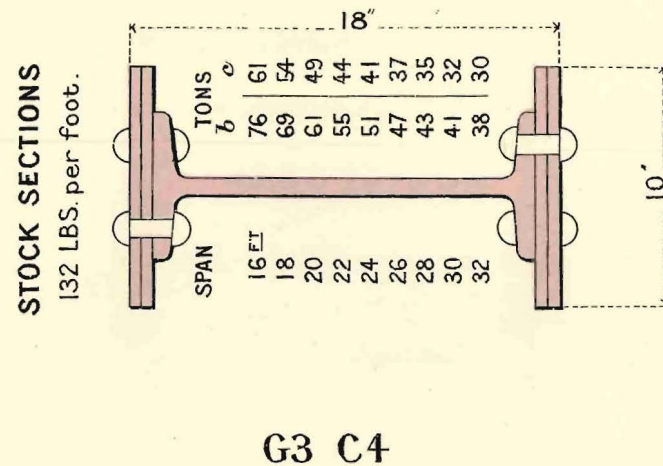
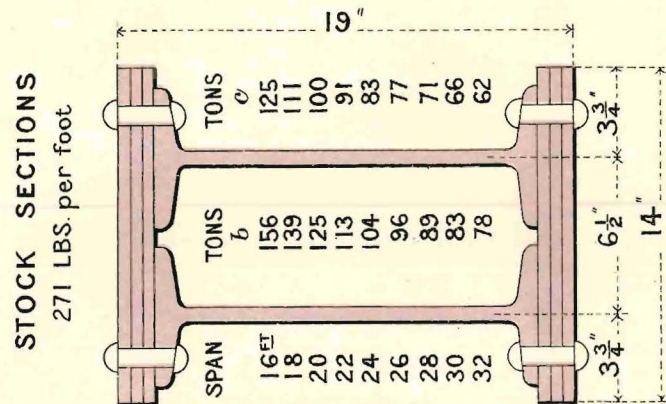

PLATE	N ^o OF SECTION	WEIGHT PER FOOT IN POUNDS	SIZES IN INCHES DPTH WDT	COMPOUNDED OF	AREA IN SQUARE INCHES	MOMENTS OF RESISTANCE IN SQUARE INCHES	VERTICAL OR GREATEST MOMENTS OF INERTIA	DISTRIBUTED LOADS IN TONS THAT ONE FOOT WILL CARRY. COEFFICIENTS OF STRESS. SEE PAGE I.	
								<i>b</i>	<i>c</i>
113	G3 C4	132	18 × 10	1G3 and 4½ plates	34.53	230.41	2073.75	1228.89	983.11

DORMAN, LONG & COMPANY, LIMITED, MIDDLESBOROUGH.

Compound Girders.

Distributed Loads in Tons for different spans, Coefficients b & c



G3 C5

PLATE 114	Nº OF SECTION	WEIGHT PER FOOT IN POUNDS	SIZES IN INCHES		COMPOUNDED OF	AREA IN SQUARE INCHES	MOMENTS OF RESISTANCE IN SQUARE INCHES	VERTICAL OR GREATEST MOMENTS OF INERTIA	DISTRIBUTED LOADS IN TONS THAT ONE FOOT WILL CARRY. COEFFICIENTS OF STRESS. SEE PAGE I.	
			DPHT	WDTH					<i>b</i>	<i>c</i>
	G3 C5	271	19	× 14	2G3 and 6 1/2" plates	69.06	469.83	4463.42	2505.78	2004.62

DORMAN, LONG & COMPANY, LIMITED, MIDDLESBOROUGH.

Compound Girders.

Distributed Loads in Tons for different spans, Coefficients b & c

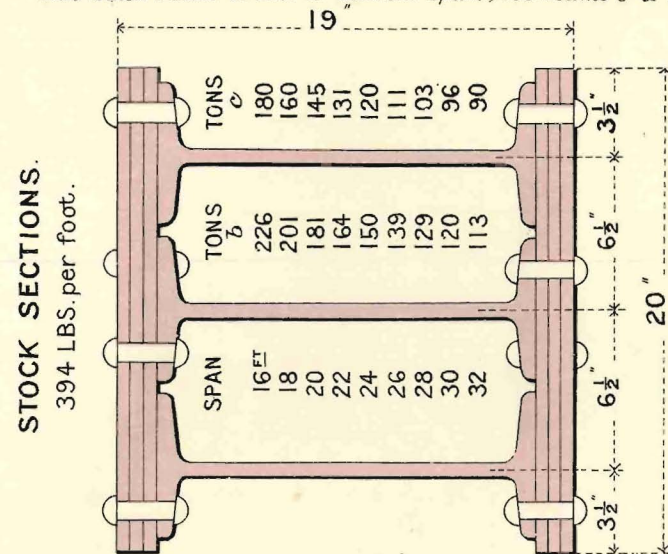

G3 C6

PLATE 115	Nº OF SECTION	WEIGHT PER FOOT IN POUNDS	SIZES IN INCHES		COMPOUNDED OF	AREA IN SQUARE INCHES	MOMENTS OF RESISTANCE IN SQUARE INCHES	VERTICAL OR GREATEST MOMENTS OF INERTIA	DISTRIBUTED LOADS IN TONS THAT ONE FOOT WILL CARRY. COEFFICIENTS OF STRESS. SEE PAGE I.	
			DPHT	WDTH					<i>b</i>	<i>c</i>
	G3 C6	394	19	× 20	3G3 and 6 1/2" plates	100.59	678.5	6445.75	3618.67	2894.83

DORMAN, LONG & COMPANY, LIMITED, MIDDLESBOROUGH.

Compound Girders.

Distributed Loads in Tons for different spans, Coefficients *b* & *c*.

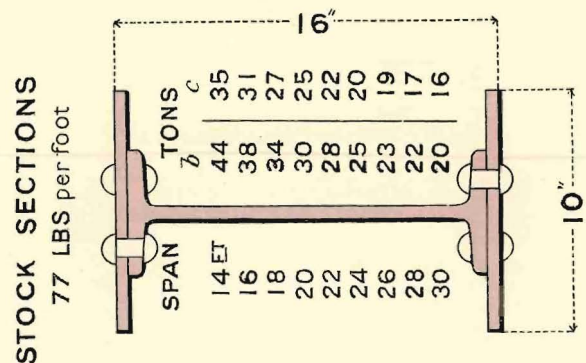

G5 C1

PLATE 116	N ^o OF SECTION	WEIGHT PER FOOT IN POUNDS	SIZES IN INCHES DPTH WDT	COMPOUNDED OF	AREA IN SQUARE INCHES	MOMENTS OF RESISTANCE IN SQUARE INCHES	VERTICAL OR GREATEST MOMENTS OF INERTIA	DISTRIBUTED LOADS IN TONS THAT ONE FOOT WILL CARRY. SEE PAGE I.	
								<i>b</i>	<i>c</i>
	G5 C1	77	16 × 10	1G5 and 2½" plates	20.03	116.03	928.27	618.85	495.08

DORMAN, LONG & COMPANY, LIMITED, MIDDLESBOROUGH.

Compound Girders.

Distributed Loads in Tons for different spans, Coefficients *b* & *c*.

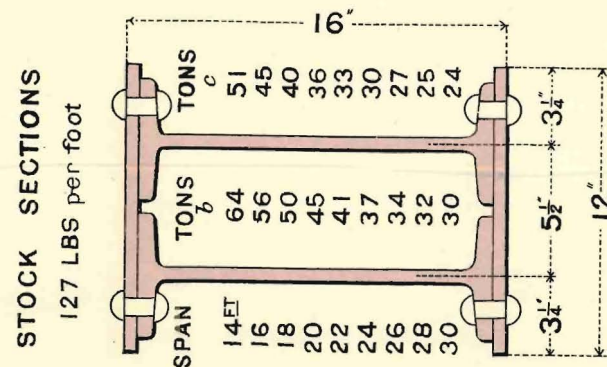

G5 C2

PLATE 117	N ^o OF SECTION	WEIGHT PER FOOT IN POUNDS	SIZES IN INCHES DPTH WDT	COMPOUNDED OF	AREA IN SQUARE INCHES	MOMENTS OF RESISTANCE IN SQUARE INCHES	VERTICAL OR GREATEST MOMENTS OF INERTIA	DISTRIBUTED LOADS IN TONS THAT ONE FOOT WILL CARRY. SEE PAGE I.	
								<i>b</i>	<i>c</i>
	G5 C2	127	16 × 12	2G5 and 2½" plates	32.06	170.04	1360.54	907.03	725.62

DORMAN, LONG & COMPANY, LIMITED, MIDDLESBOROUGH.

Compound Girders.

Distributed Loads in Tons for different spans, Coefficients *b* & *c*

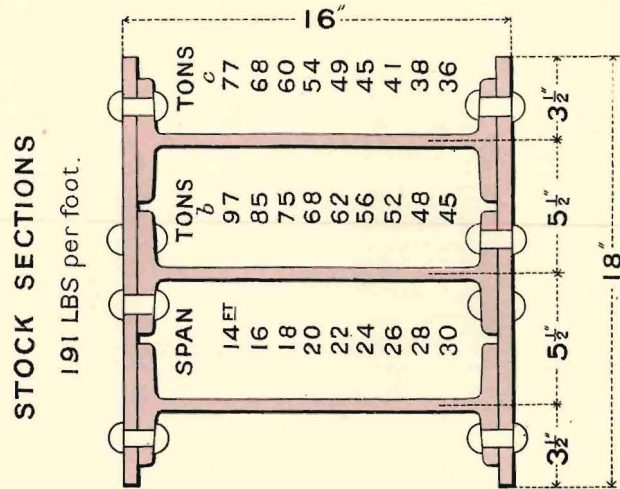

G5 C3

PLATE 118	N ^o OF SECTION	WEIGHT PER FOOT IN POUNDS	SIZES IN INCHES DPHT WDT	COMPOUNDED OF	AREA IN SQUARE INCHES	MOMENTS OF RESISTANCE IN SQUARE INCHES	VERTICAL OR GREATEST MOMENTS OF INERTIA	DISTRIBUTED LOADS IN TONS THAT ONE FOOT WILL CARRY. COEFFICIENTS OF STRESS. SEE PAGE I.	
								<i>b</i>	<i>c</i>
	G5 C3	191	16 × 18	3G5 and 2- $\frac{1}{2}$ " plates	48.09	255.1	2040.82	1360.55	1088.44

DORMAN, LONG & COMPANY, LIMITED, MIDDLESBOROUGH.

Compound Girders.

Distributed Loads in Tons for different spans, Coefficients *b* & *c*

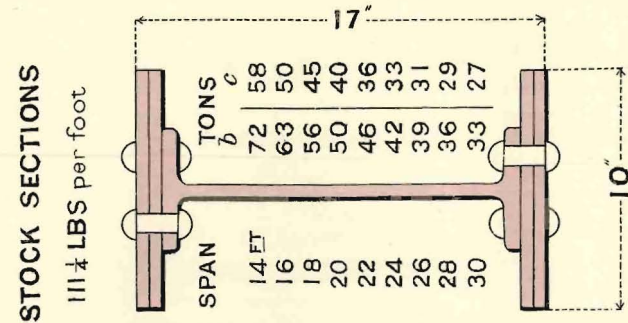

G5 C4

PLATE 119	N ^o OF SECTION	WEIGHT PER FOOT IN POUNDS	SIZES IN INCHES DPHT WDT	COMPOUNDED OF	AREA IN SQUARE INCHES	MOMENTS OF RESISTANCE IN SQUARE INCHES	VERTICAL OR GREATEST MOMENTS OF INERTIA	DISTRIBUTED LOADS IN TONS THAT ONE FOOT WILL CARRY. COEFFICIENTS OF STRESS. SEE PAGE I.	
								<i>b</i>	<i>c</i>
	G5 C4	111.25	17 × 18	1G5 and 4- $\frac{1}{2}$ " plates	29.03	190.33	1617.38	1014.83	811.86

DORMAN, LONG & COMPANY, LIMITED, MIDDLESBOROUGH.

Compound Girders.

Distributed Loads in Tons for different spans, Coefficients *b* & *c*

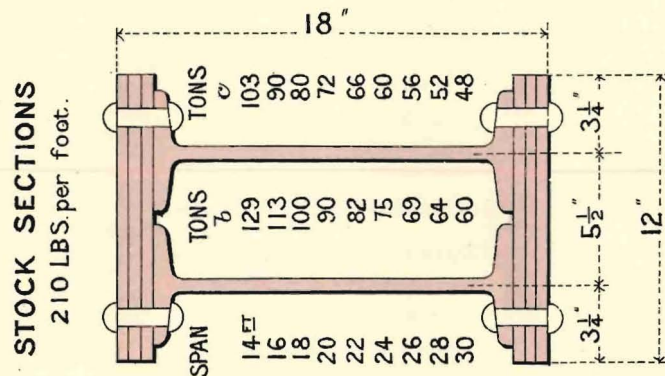

G5 C5

PLATE 120	N ^o OF SECTION	WEIGHT PER FOOT IN POUNDS	SIZES IN INCHES DEPTH WIDTH	COMPOUNDED OF	AREA IN SQUARE INCHES	MOMENTS OF RESISTANCE IN SQUARE INCHES	VERTICAL OR GREATEST MOMENTS OF INERTIA	DISTRIBUTED LOADS IN TONS THAT ONE FOOT WILL CARRY. SEE PAGE I.	
								<i>b</i>	<i>c</i>
	G5 C5	210	18 × 12	2G5 and 6- ¹ / ₂ " plates	52.06	340.06	3060.61	1813.7	1450.96

DORMAN, LONG & COMPANY, LIMITED, MIDDLESBOROUGH.

Compound Girders.

Distributed Loads in Tons for different spans, Coefficients *b* & *c*

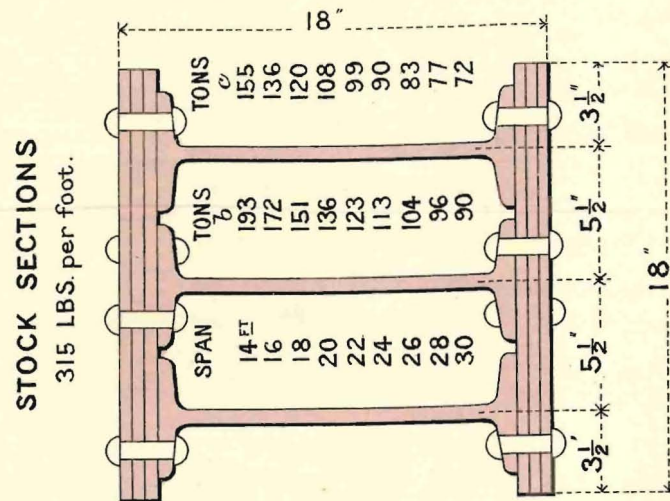

G5 C6

PLATE 121	N ^o OF SECTION	WEIGHT PER FOOT IN POUNDS	SIZES IN INCHES DEPTH WIDTH	COMPOUNDED OF	AREA IN SQUARE INCHES	MOMENTS OF RESISTANCE IN SQUARE INCHES	VERTICAL OR GREATEST MOMENTS OF INERTIA	DISTRIBUTED LOADS IN TONS THAT ONE FOOT WILL CARRY. SEE PAGE I.	
								<i>b</i>	<i>c</i>
	G5 C6	315	18 × 18	3G5 and 6- ¹ / ₂ " plates	78.09	510.1	4590.92	2720.55	2176.44

DORMAN, LONG & COMPANY, LIMITED, MIDDLESBOROUGH.

Compound Girders. STOCK SECTIONS

Distributed Loads in Tons for different spans, Coefficients b & c

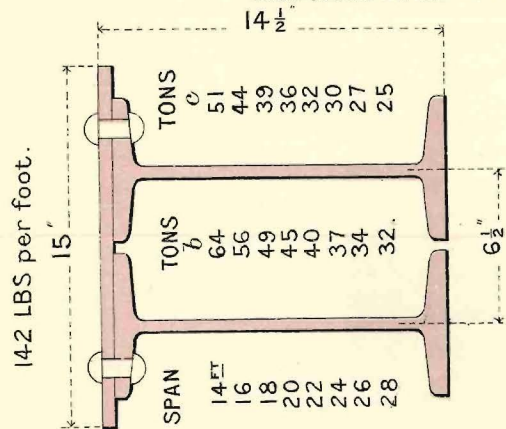

G6 C1

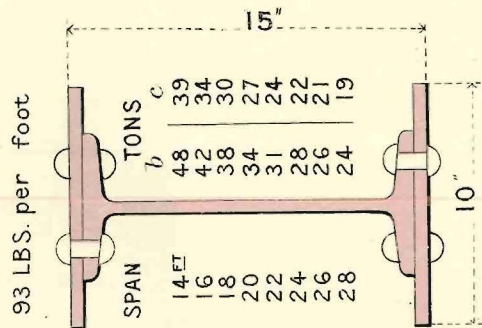

G6 C2

PLATE 122	Nº OF SECTION	WEIGHT PER FOOT IN POUNDS	SIZES IN INCHES DPTH WDT	COMPOUNDED OF	AREA IN SQUARE INCHES	MOMENTS OF RESISTANCE IN SQUARE INCHES	VERTICAL OR GREATEST MOMENTS OF INERTIA	DISTRIBUTED LOADS IN TONS THAT ONE FOOT WILL CARRY. COEFFICIENTS OF STRESS. SEE PAGE I.	
								<i>b</i>	<i>c</i>
	G6 C1	142	14 1/2 x 15	2G6 and 1 1/2 plate	38.22	168.38	1338.46	898.33	718.66
	G6 C2	93	15 x 10	1G6 and 2 1/2 plates	24.01	128.39	962.95	684.77	547.81

DORMAN, LONG & COMPANY, LIMITED, MIDDLESBOROUGH.

Compound Girders. STOCK SECTIONS

Distributed Loads in Tons for different spans, Coefficients b & c

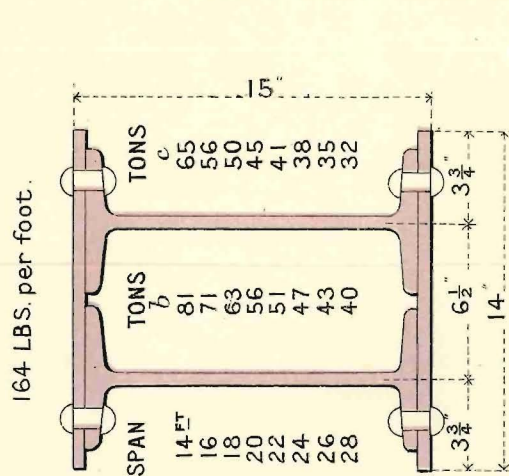

G6 C3

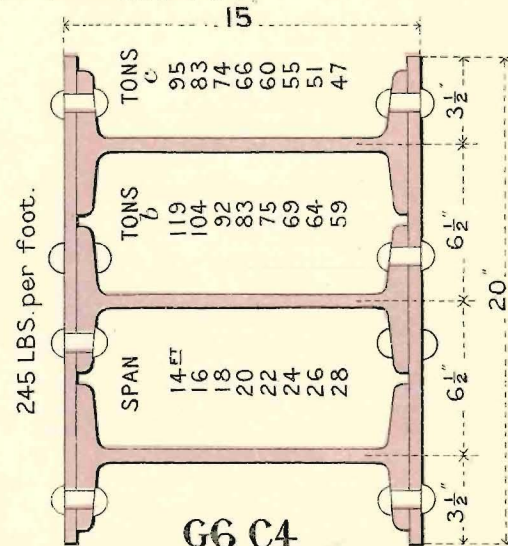

G6 C4

PLATE 123	Nº OF SECTION	WEIGHT PER FOOT IN POUNDS	SIZES IN INCHES DPTH WDT	COMPOUNDED OF	AREA IN SQUARE INCHES	MOMENTS OF RESISTANCE IN SQUARE INCHES	VERTICAL OR GREATEST MOMENTS OF INERTIA	DISTRIBUTED LOADS IN TONS THAT ONE FOOT WILL CARRY. COEFFICIENTS OF STRESS. SEE PAGE I.	
								<i>b</i>	<i>c</i>
	G6 C3	164	15 x 14	2G6 and 2 1/2 plates	42.02	213.42	1599.66	1137.54	910.03
	G6 C4	245	15 x 20	3G6 and 2 1/2 plates	62.03	312.68	2345.11	1667.64	1334.11

DORMAN, LONG & COMPANY, LIMITED, MIDDLESBOROUGH.

Compound Girders. STOCK SECTIONS

Distributed Loads in Tons for different spans, Coefficients b & c

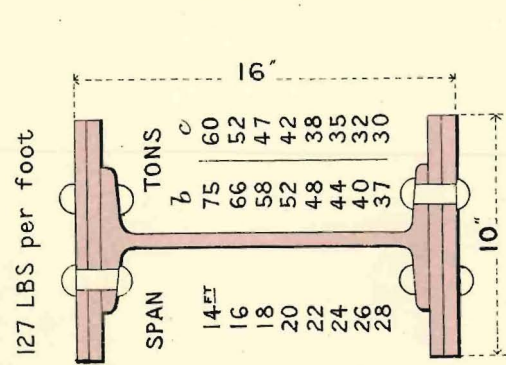

G6 C5

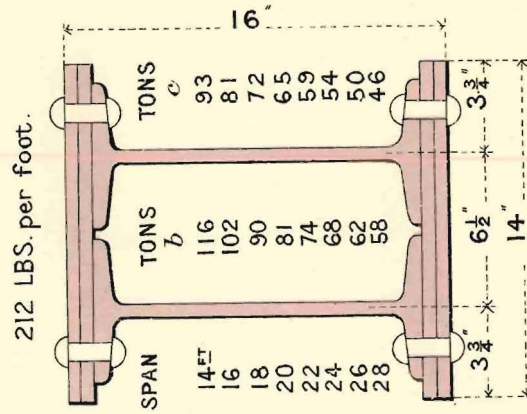

G6 C6

PLATE 124	Nº OF SECTION	WEIGHT PER FOOT IN POUNDS	SIZES IN INCHES DPHT WPTH	COMPOUNDED OF	AREA IN SQUARE INCHES	MOMENTS OF RESISTANCE IN SQUARE INCHES	VERTICAL OR GREATEST MOMENTS OF INERTIA	DISTRIBUTED LOADS IN TONS THAT ONE FOOT WILL CARRY. COEFFICIENTS OF STRESS. SEE PAGE I.	
								b	c
	G6 C5	127	16 x 10	1 G6 and 4 1/2 plates	33.01	198.14	1585.15	1056.77	845.41
	G6 C6	212	16 x 14	2 G6 and 4 1/2 plates	54.02	306.29	2450.31	1633.54	1306.83

DORMAN, LONG & COMPANY, LIMITED, MIDDLESBOROUGH.

Compound Girders. STOCK SECTIONS

Distributed Loads in Tons for different spans, Coefficients b & c

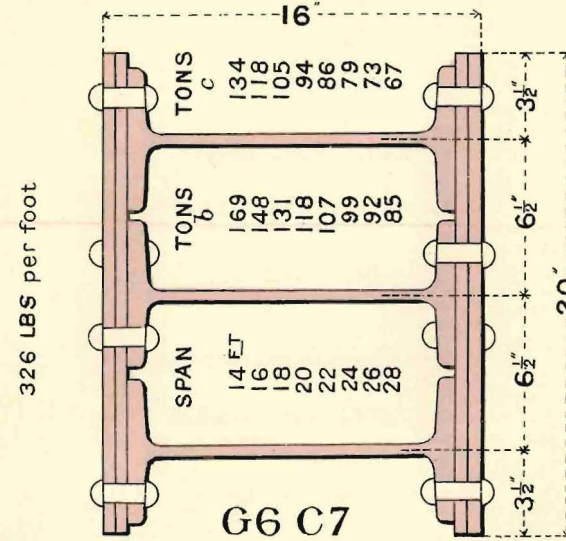

G6 C7

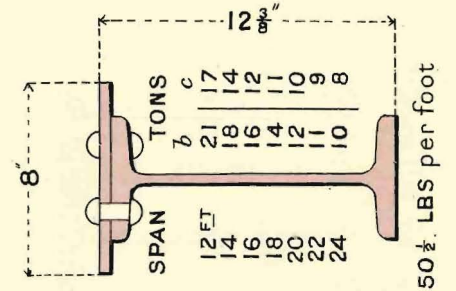

G8 C1

PLATE 125	Nº OF SECTION	WEIGHT PER FOOT IN POUNDS	SIZES IN INCHES DPHT WPTH	COMPOUNDED OF	AREA IN SQUARE INCHES	MOMENTS OF RESISTANCE IN SQUARE INCHES	VERTICAL OR GREATEST MOMENTS OF INERTIA	DISTRIBUTED LOADS IN TONS THAT ONE FOOT WILL CARRY. COEFFICIENTS OF STRESS. SEE PAGE I.	
								b	c
	G6 C7	326	16 x 20	3 G6 and 4 1/2 plates	79.03	444.43	3555.46	2370.31	1896.24
	G8 C1	50.5	12 3/8 x 8	1 G8 and 1 3/8 plate	13.38	48.34	340.59	257.83	206.26

DORMAN, LONG & COMPANY, LIMITED, MIDDLESBOROUGH.

Compound Girders. STOCK SECTIONS

Distributed Loads in Tons for different spans, Coefficients b & c

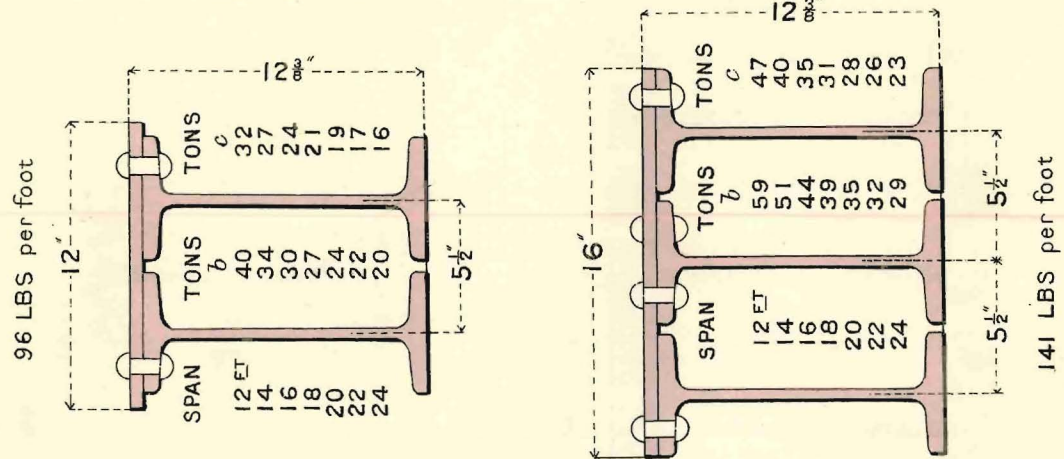

G8 C2

G8 C3

PLATE 126	NO OF SECTION	WEIGHT PER FOOT IN POUNDS	SIZES IN INCHES DPH WDH	COMPOUNDED OF	AREA IN SQUARE INCHES	MOMENTS OF RESISTANCE IN SQUARE INCHES	VERTICAL OR GREATEST MOMENTS OF INERTIA	DISTRIBUTED LOADS IN TONS THAT ONE FOOT WILL CARRY. COEFFICIENTS OF STRESS. SEE PAGE 1.	
								b	c
	G8 C2	96	12 ³ / ₈ × 12	2G8 and 1 ³ / ₈ " plate	25.26	91.1	614.98	485.9	388.72
	G8 C3	141	12 ³ / ₈ × 16	3G8 and 1 ³ / ₈ " plate	37.13	133.83	886.66	713.78	571.02

DORMAN, LONG & COMPANY, LIMITED, MIDDLESBOROUGH.

Compound Girders. STOCK SECTIONS

Distributed Loads in Tons for different spans, Coefficients b & c

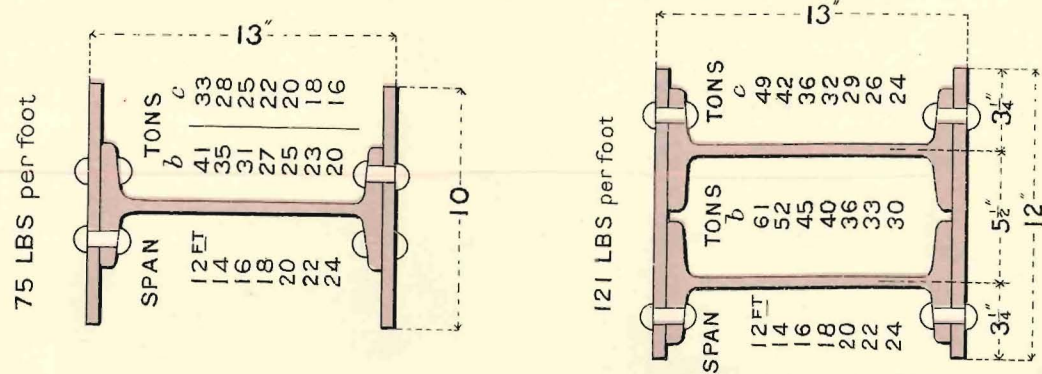

G8 C4

G8 C5

PLATE 127	NO OF SECTION	WEIGHT PER FOOT IN POUNDS	SIZES IN INCHES DPH WDH	COMPOUNDED OF	AREA IN SQUARE INCHES	MOMENTS OF RESISTANCE IN SQUARE INCHES	VERTICAL OR GREATEST MOMENTS OF INERTIA	DISTRIBUTED LOADS IN TONS THAT ONE FOOT WILL CARRY. COEFFICIENTS OF STRESS. SEE PAGE 1.	
								b	c
	G8 C4	75	13 × 10	1G8 and 2- ¹ / ₂ " plates	19.36	93.84	609.97	500.49	400.39
	G8 C5	121	13 × 12	2G8 and 2- ¹ / ₂ " plates	30.68	137.68	894.94	734.31	587.44

DORMAN, LONG & COMPANY, LIMITED, MIDDLESBOROUGH.

Compound Girders. STOCK SECTIONS

Distributed Loads in Tons for different spans, Coefficients *b* & *c*

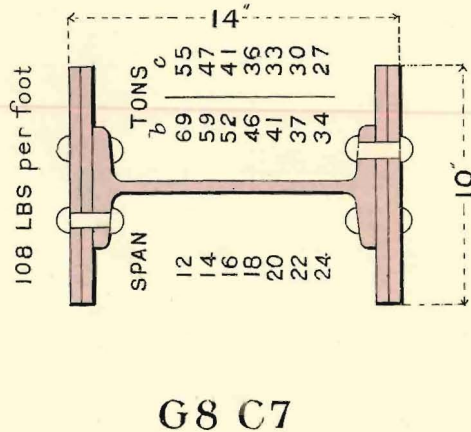
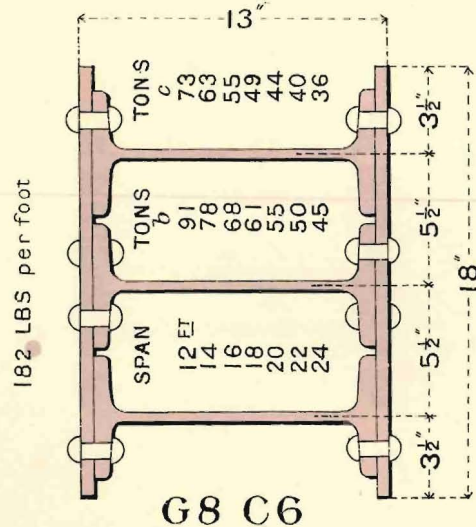

PLATE 128	Nº OF SECTION	WEIGHT PER FOOT IN POUNDS	SIZES IN INCHES DPTH WDTH	COMPOUNDED OF	AREA IN SQUARE INCHES	MOMENTS OF RESISTANCE IN SQUARE INCHES	VERTICAL OR GREATEST MOMENTS OF INERTIA	DISTRIBUTED LOADS IN TONS THAT ONE FOOT WILL CARRY. COEFFICIENTS OF STRESS. SEE PAGE I.	
								<i>b</i>	<i>c</i>
	G8 C6	182	13 × 18	3G8 and 2-1/2 plates	46.06	206.52	1342.41	1101.47	881.17
	G8 C7	108	14 × 10	1G8 and 4-1/2 plates	28.52	155.85	1091.0	831.24	664.99

DORMAN, LONG & COMPANY, LIMITED, MIDDLESBOROUGH.

Compound Girders. STOCK SECTIONS

Distributed Loads in Tons for different spans, Coefficients *b* & *c*

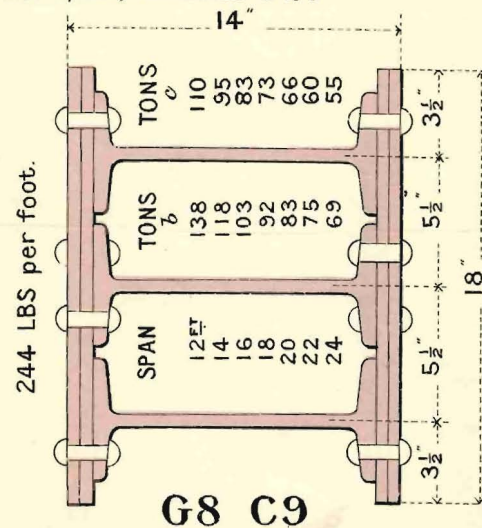
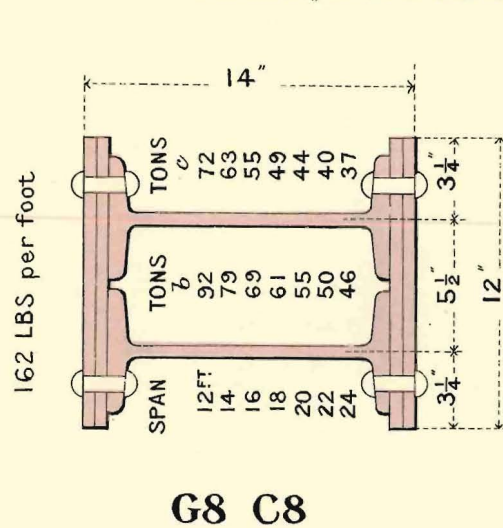
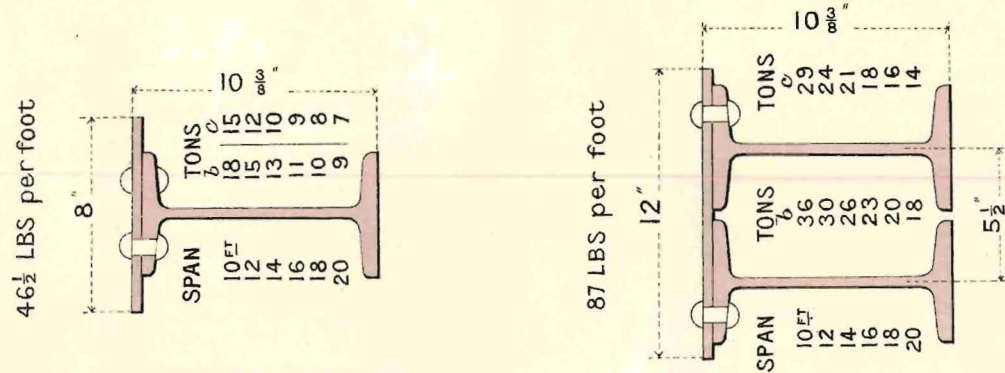

PLATE 129	Nº OF SECTION	WEIGHT PER FOOT IN POUNDS	SIZES IN INCHES DPTH WDTH	COMPOUNDED OF	AREA IN SQUARE INCHES	MOMENTS OF RESISTANCE IN SQUARE INCHES	VERTICAL OR GREATEST MOMENTS OF INERTIA	DISTRIBUTED LOADS IN TONS THAT ONE FOOT WILL CARRY. COEFFICIENTS OF STRESS. SEE PAGE I.	
								<i>b</i>	<i>c</i>
	G8 C8	162	14 × 12	2G8 and 4-1/2 plates	41.08	207.7	1454.0	1107.81	886.24
	G8 C9	244	14 × 18	3G8 and 4-1/2 plates	61.62	311.55	2181.00	1661.72	1329.37

DORMAN, LONG & COMPANY, LIMITED, MIDDLESBOROUGH.

Compound Girders. STOCK SECTIONS

Distributed Loads in Tons for different spans, Coefficients b & c



G10 C1

G10 C2

PLATE 130	Nº OF SECTION	WEIGHT PER FOOT IN POUNDS	SIZES IN INCHES DPTH WTDH	COMPOUNDED OF	AREA IN SQUARE INCHES	MOMENTS OF RESISTANCE IN SQUARE INCHES	VERTICAL OR GREATEST MOMENTS OF INERTIA	DISTRIBUTED LOADS IN TONS THAT ONE FOOT WILL CARRY. COEFFICIENTS OF STRESS. SEE PAGE I.	
								b	c
	G10 C1	46.5	10 ^{3/8} × 8	1G10 and 1 ^{3/8} " plate	12.44	35.25	209.61	187.94	150.35
	G10 C2	87	10 ^{3/4} × 12	2G10 and 1 ^{3/8} " plate	23.38	68.93	390.67	367.66	294.15

DORMAN, LONG & COMPANY, LIMITED, MIDDLESBOROUGH.

Compound Girders. STOCK SECTIONS.

Distributed Loads in Tons for different spans, Coefficients b & c

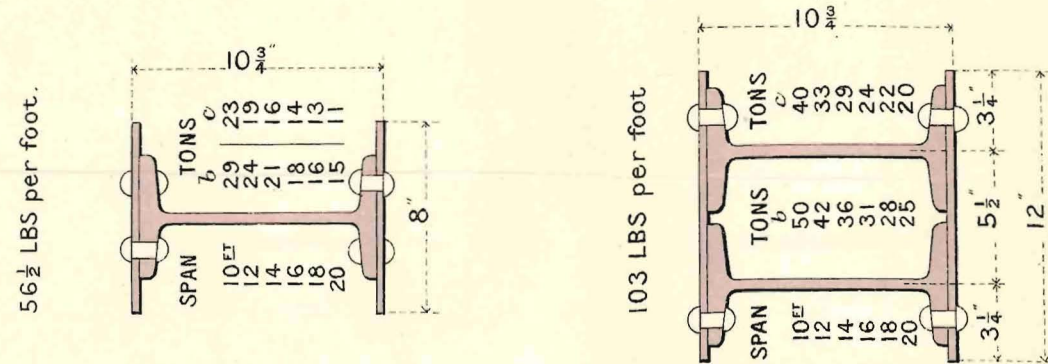

G10 C3

G10 C4

PLATE 131	Nº OF SECTION	WEIGHT PER FOOT IN POUNDS	SIZES IN INCHES DPTH WTDH	COMPOUNDED OF	AREA IN SQUARE INCHES	MOMENTS OF RESISTANCE IN SQUARE INCHES	VERTICAL OR GREATEST MOMENTS OF INERTIA	DISTRIBUTED LOADS IN TONS THAT ONE FOOT WILL CARRY. COEFFICIENTS OF STRESS. SEE PAGE I.	
								b	c
	G10 C3	56.5	10 ^{3/4} × 8	1G10 and 2 ^{3/8} " plates	14.66	55.37	297.66	295.34	236.27
	G10 C4	103	10 ^{3/4} × 12	2G10 and 2 ^{3/8} " plates	26.32	95.18	511.6	507.64	406.11

DORMAN, LONG & COMPANY, LIMITED, MIDDLESBOROUGH.

Compound Girders. STOCK SECTIONS

Distributed Loads in Tons for different spans, Coefficients *b* & *c*

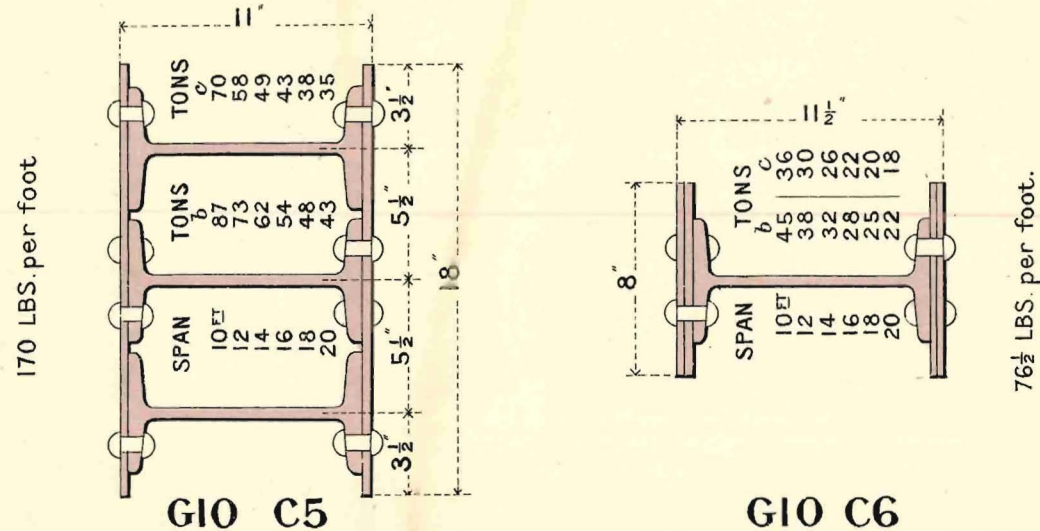

PLATE 132	N ^o OF SECTION	WEIGHT PER FOOT IN POUNDS	SIZES IN INCHES DPHT WDTH	COMPOUNDED OF	AREA IN SQUARE INCHES	MOMENTS OF RESISTANCE IN SQUARE INCHES	VERTICAL OR GREATEST MOMENTS OF INERTIA	DISTRIBUTED LOADS IN TONS THAT ONE FOOT WILL CARRY.	
								COEFFICIENTS OF STRESS. SEE PAGE I.	
								<i>b</i>	<i>c</i>
	G10 C5	170	11 × 18	3G10 and 2½" plates	39.72	163.94	901.67	874.35	699.48
	G10 C6	76.5	11½ × 8	1G10 and 4¾" plates	20.06	83.48	480.04	455.26	364.21

DORMAN, LONG & COMPANY, LIMITED, MIDDLESBOROUGH.

Compound Girders. STOCK SECTIONS

Distributed Loads in Tons for different spans, Coefficients *b* & *c*

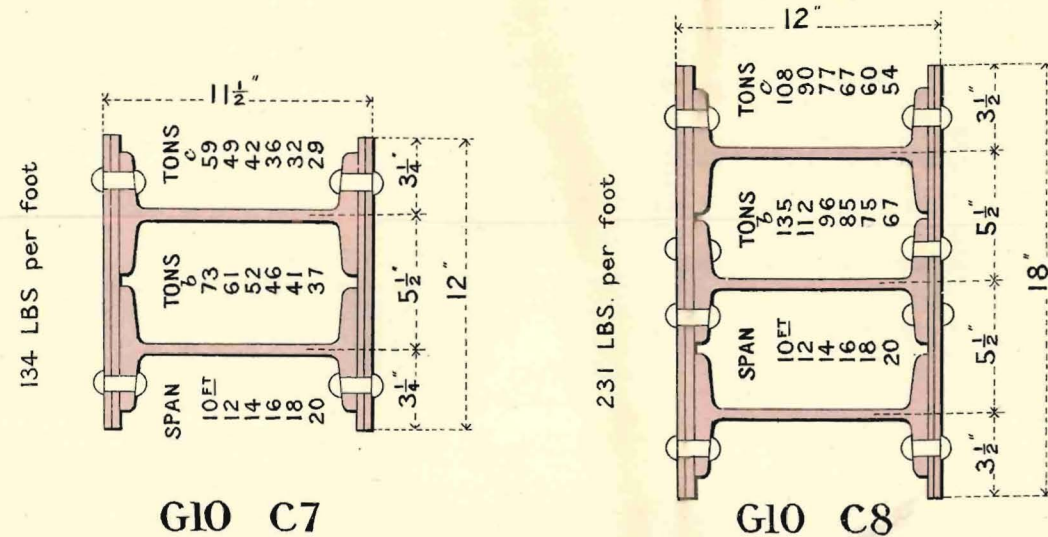
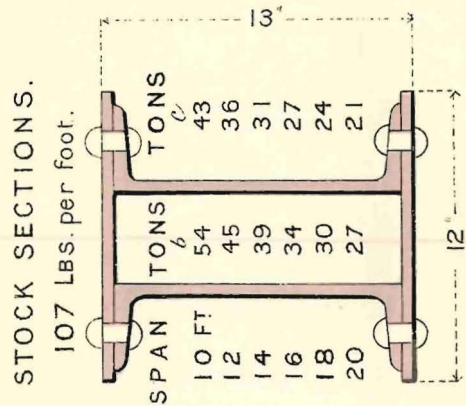

PLATE 133	N ^o OF SECTION	WEIGHT PER FOOT IN POUNDS	SIZES IN INCHES DPHT WDTH	COMPOUNDED OF	AREA IN SQUARE INCHES	MOMENTS OF RESISTANCE IN SQUARE INCHES	VERTICAL OR GREATEST MOMENTS OF INERTIA	DISTRIBUTED LOADS IN TONS THAT ONE FOOT WILL CARRY.	
								COEFFICIENTS OF STRESS. SEE PAGE I.	
								<i>b</i>	<i>c</i>
	G10 C7	134	11½ × 12	2G10 and 4¾" plates	34.12	138.47	796.21	738.52	590.81
	G10 C8	231	12 × 18	3G10 and 4½" plates	51.46	253.42	1520.56	1351.6	1081.28

DORMAN, LONG & COMPANY, LIMITED, MIDDLESBOROUGH.

Compound Girders.

Distributed Loads in Tons for different spans, Coefficients *b* & *c*



C12 C1.

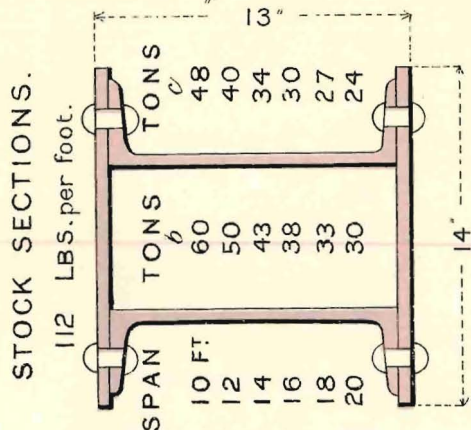

C12 C2.

PLATE 134	N° OF SECTION	WEIGHT PER FOOT IN POUNDS	SIZES IN INCHES DPHT WDT	COMPOUNDED OF	AREA IN SQUARE INCHES	MOMENTS OF RESISTANCE IN SQUARE INCHES	VERTICAL OR GREATEST MOMENTS OF INERTIA	DISTRIBUTED LOADS IN TONS THAT ONE FOOT WILL CARRY. COEFFICIENTS OF STRESS. SEE PAGE I.	
								<i>b</i>	<i>c</i>
	C12 C1	107	13 × 12	2C12 & 2- $\frac{1}{2}$ " plates	26·72	102·31	665·02	545·65	436·52
	C12 C2	112	13 × 14	2C12 & 2- $\frac{1}{2}$ " plates	28·72	114·32	743·12	609·73	487·79

DORMAN, LONG & COMPANY, LIMITED, MIDDLESBOROUGH.

Compound Girders.

Distributed Loads in Tons for different spans, Coefficients *b* & *c*

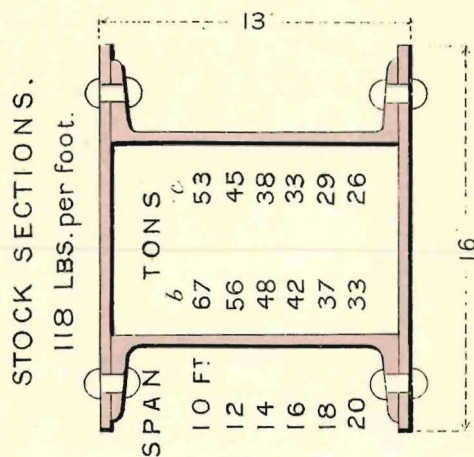

C12 C3.

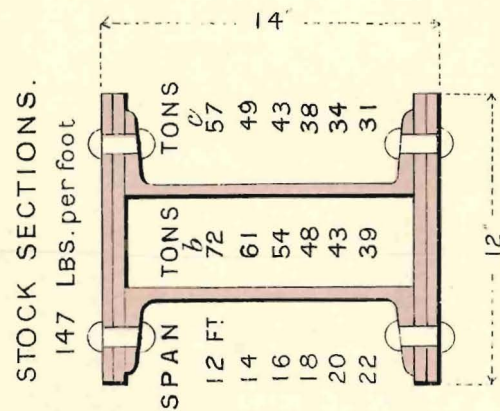

C12 C4.

PLATE 135	N° OF SECTION	WEIGHT PER FOOT IN POUNDS	SIZES IN INCHES DPHT WDT	COMPOUNDED OF	AREA IN SQUARE INCHES	MOMENTS OF RESISTANCE IN SQUARE INCHES	VERTICAL OR GREATEST MOMENTS OF INERTIA	DISTRIBUTED LOADS IN TONS THAT ONE FOOT WILL CARRY. COEFFICIENTS OF STRESS. SEE PAGE I.	
								<i>b</i>	<i>c</i>
	C12 C3	118	13 × 16	2C12 & 2- $\frac{1}{2}$ " plates	30·72	126·34	821·26	673·85	539·08
	C12 C4	147	14 × 12	2C12 & 4- $\frac{1}{2}$ " plates	37·08	162·25	1135·78	865·35	692·28

DORMAN, LONG & COMPANY, LIMITED, MIDDLESBOROUGH.

Compound Girders.

Distributed Loads in Tons for different spans, Coefficients *b* & *c*

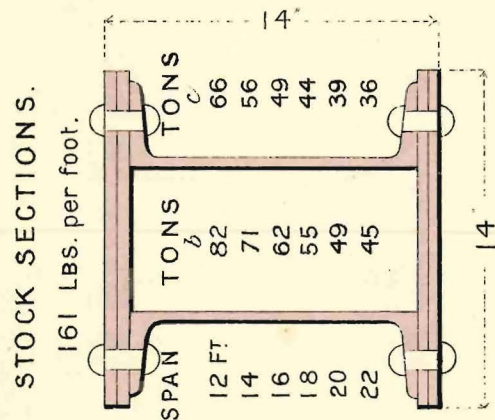

C12 C5.

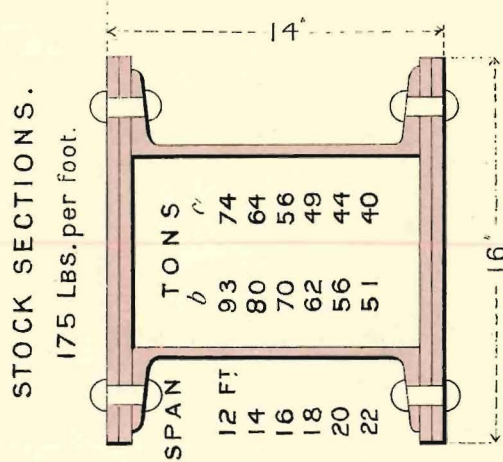

C12 C6

PLATE 136	Nº OF SECTION	WEIGHT PER FOOT IN POUNDS	SIZES IN INCHES DPH WDH	COMPOUNDED OF	AREA IN SQUARE INCHES	MOMENTS OF RESISTANCE IN SQUARE INCHES	VERTICAL OR GREATEST MOMENTS OF INERTIA	DISTRIBUTED LOADS IN TONS THAT ONE FOOT WILL CARRY. COEFFICIENTS OF STRESS. SEE PAGE I.	
								<i>b</i>	<i>c</i>
	C12 C5	161	14 x 14	2C12 & 4- $\frac{1}{2}$ " plates	41.08	186.39	1304.78	994.11	795.29
	C12 C6	175	14 x 16	2C12 & 4- $\frac{1}{2}$ " plates	45.08	210.54	1473.78	1122.88	898.3

DORMAN, LONG & COMPANY, LIMITED, MIDDLESBOROUGH.

Compound Girders.

Distributed Loads in Tons for different spans, Coefficients *b* & *c*

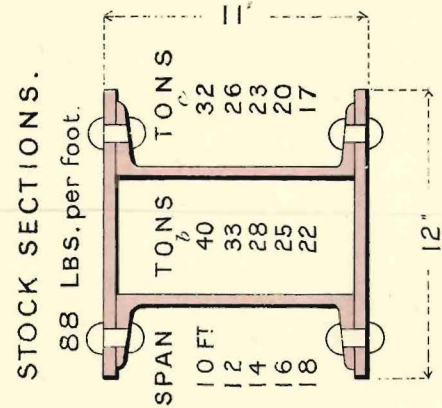

C11 C1.

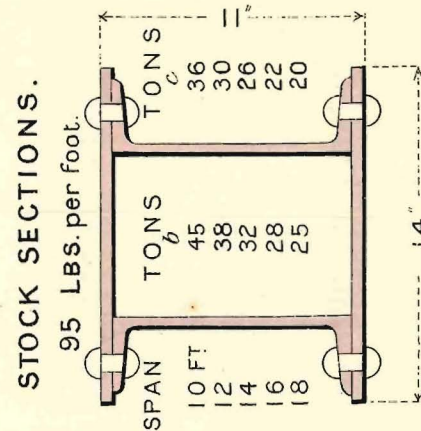

C11 C2.

PLATE 137	Nº OF SECTION	WEIGHT PER FOOT IN POUNDS	SIZES IN INCHES DPH WDH	COMPOUNDED OF	AREA IN SQUARE INCHES	MOMENTS OF RESISTANCE IN SQUARE INCHES	VERTICAL OR GREATEST MOMENTS OF INERTIA	DISTRIBUTED LOADS IN TONS THAT ONE FOOT WILL CARRY. COEFFICIENTS OF STRESS. SEE PAGE I.	
								<i>b</i>	<i>c</i>
	C11 C1	88	11 x 12	2C11 & 2- $\frac{1}{2}$ " plates	22.18	75.38	414.62	402.05	321.64
	C11 C2	95	11 x 14	2C11 & 2- $\frac{1}{2}$ " plates	24.18	85.4	469.74	455.5	364.4

DORMAN, LONG & COMPANY, LIMITED, MIDDLESBOROUGH.

Compound Girders.

Distributed Loads in Tons for different spans, Coefficients *b* & *c*

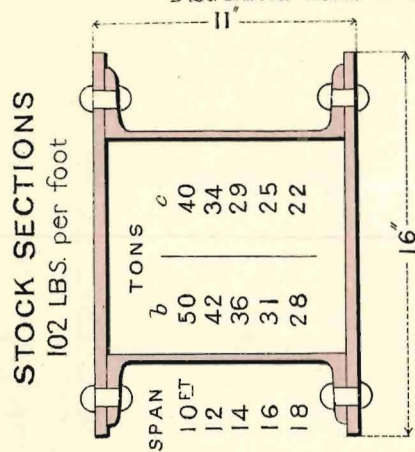

CII C3

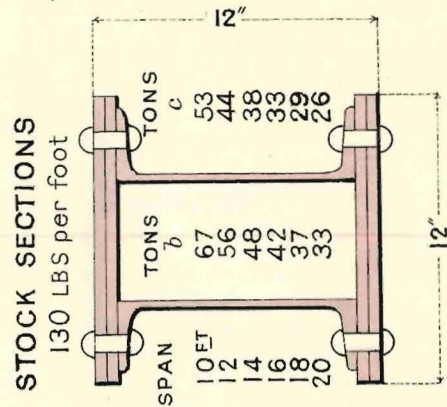

CII C4

PLATE	NO OF SECTION	WEIGHT PER FOOT IN POUNDS	SIZES IN INCHES DPTH WDT	COMPOUNDED OF	AREA IN SQUARE INCHES	MOMENTS OF RESISTANCE IN SQUARE INCHES	VERTICAL OR GREATEST MOMENTS OF INERTIA	DISTRIBUTED LOADS IN TONS THAT ONE FOOT WILL CARRY. COEFFICIENTS OF STRESS. SEE PAGE I.	
								<i>b</i>	<i>c</i>
138	CII C3	102	11 x 16	2CII & 2- $\frac{1}{2}$ " plates	26.18	95.42	524.86	508.95	407.16
	CII C4	130	12 x 12	2CII & 4- $\frac{1}{2}$ " plates	32.54	125.98	755.88	671.89	537.51

DORMAN, LONG & COMPANY, LIMITED, MIDDLESBOROUGH.

Compound Girders.

Distributed Loads in Tons for different spans, Coefficients *b* & *c*

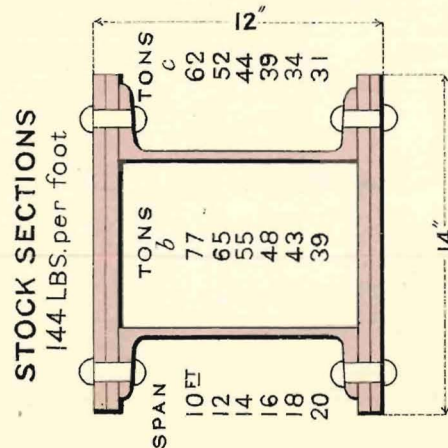

CII C5

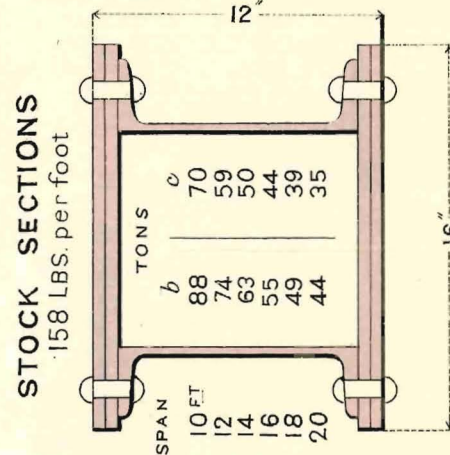

CII C6

PLATE	NO OF SECTION	WEIGHT PER FOOT IN POUNDS	SIZES IN INCHES DPTH WDT	COMPOUNDED OF	AREA IN SQUARE INCHES	MOMENTS OF RESISTANCE IN SQUARE INCHES	VERTICAL OR GREATEST MOMENTS OF INERTIA	DISTRIBUTED LOADS IN TONS THAT ONE FOOT WILL CARRY. COEFFICIENTS OF STRESS. SEE PAGE I.	
								<i>b</i>	<i>c</i>
139	CII C5	144	12 x 14	2CII & 4- $\frac{1}{2}$ " plates	36.54	146.14	876.88	779.44	623.55
	CII C6	158	12 x 16	2CII & 4- $\frac{1}{2}$ " plates	40.54	166.31	997.88	887.0	709.6

DORMAN, LONG & COMPANY, LIMITED, MIDDLESBOROUGH.

DETAILS OF CONNECTIONS.

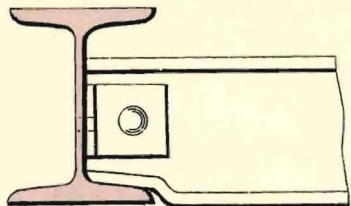

CONNECTION "A"
JOGGLE

*In ordering please state
reference letter*

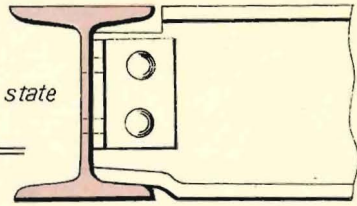

CONNECTION "B"
JOGGLE & NOTCH

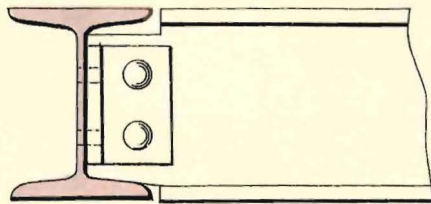

CONNECTION "C"
DOUBLE NOTCH

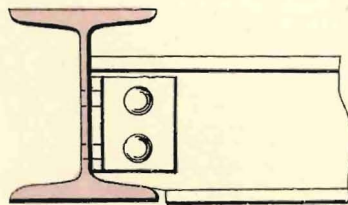

CONNECTION "D"
NOTCH AT BOTTOM.

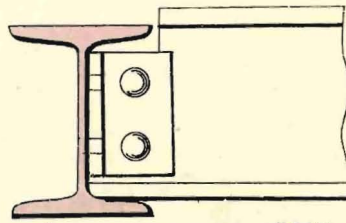

CONNECTION "E"
NOTCH AT TOP.

DORMAN, LONG & COMPANY, LIMITED, MIDDLESBOROUGH.

DETAILS OF CONSTRUCTION.

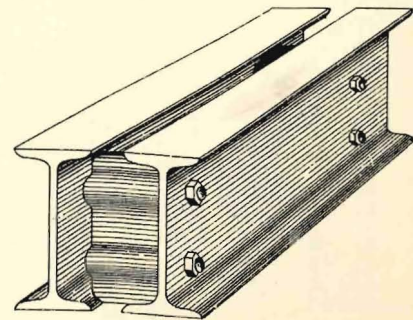
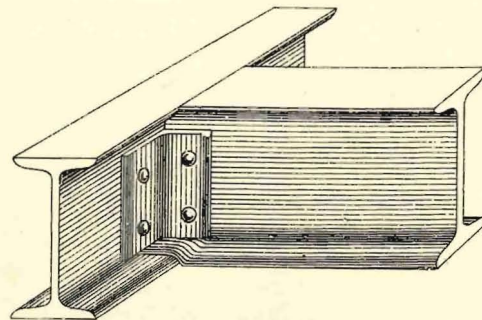
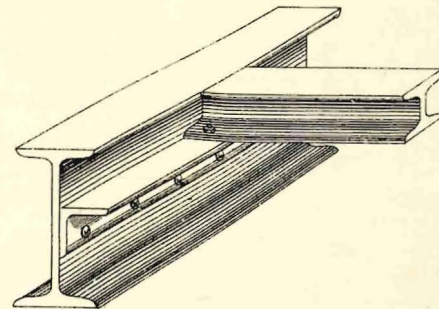
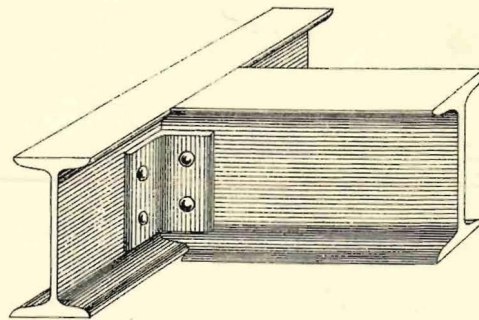

DORMAN, LONG & COMPANY, LIMITED, MIDDLESBOROUGH.

DETAILS OF CONSTRUCTION.

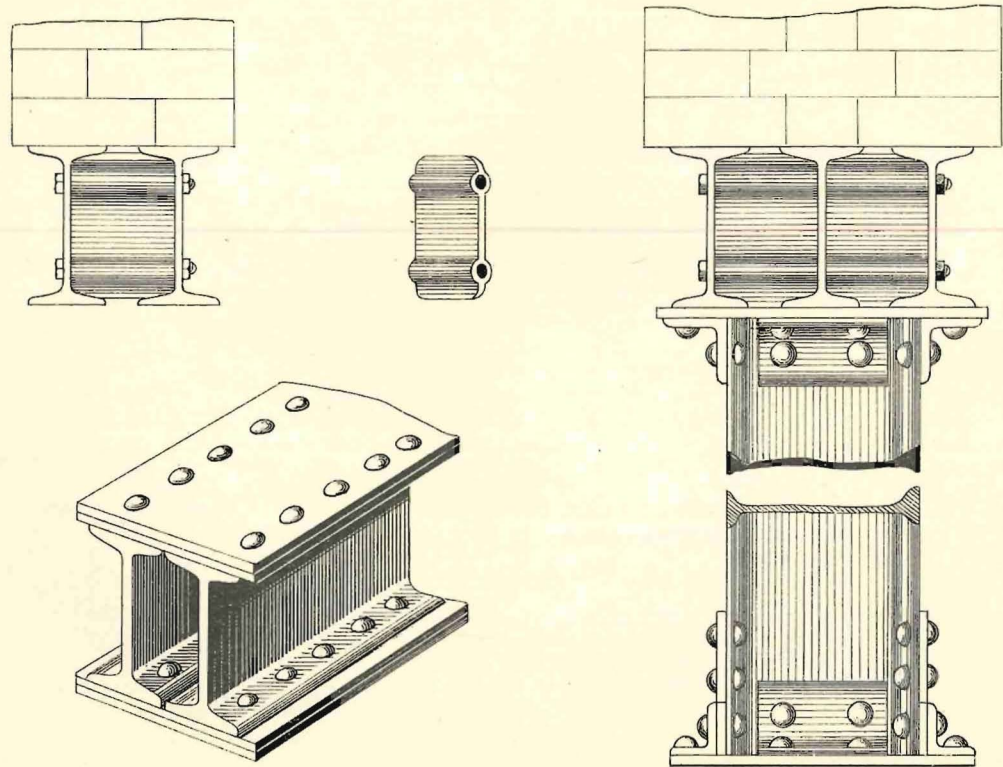

DORMAN, LONG & COMPANY, LIMITED, MIDDLESBOROUGH.

SECTIONS OF RIVETED STEEL STANCHEONS.

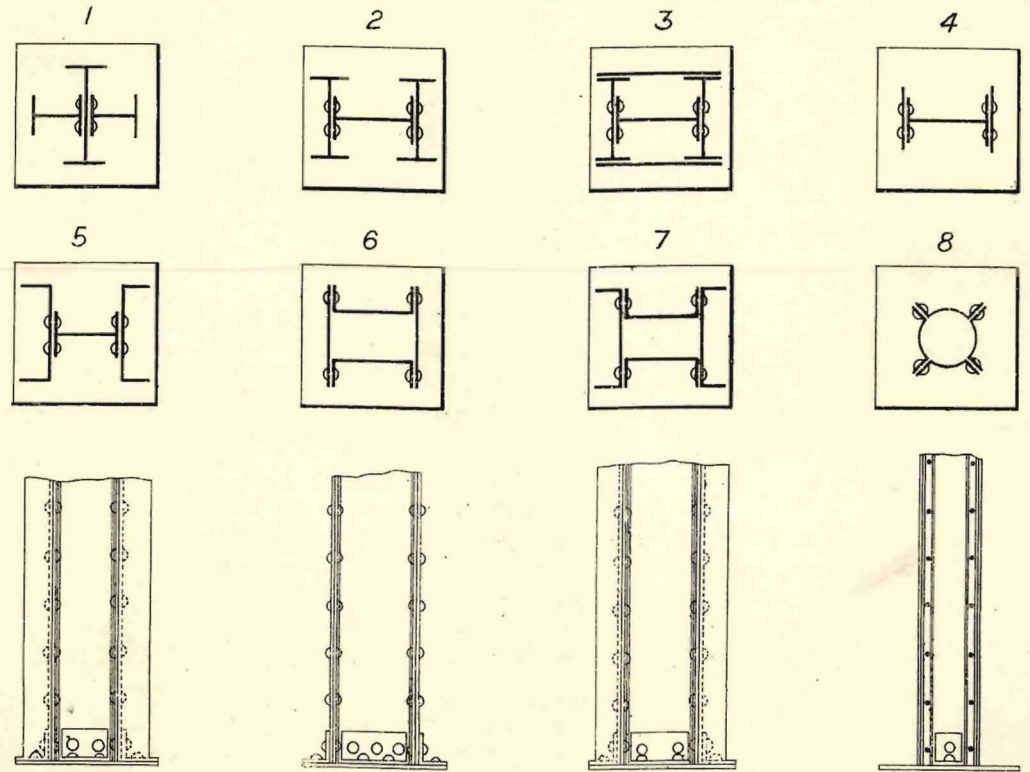

Estimates given.

Calculated Breaking Loads in tons, of Joists, used as Columns, with ends fixed. The working load should not exceed 1-4th for stationary loads, and 1-6th for moving loads.

Section.	Weight per Foot in Lbs.	Length of Column in Feet.											
		7	8	9	10	11	12	13	14	15	16	18	20
20 × 7½	89	628	607	582	563	542	514	488	456	435	404	353	309
18 × 7	75	523	508	484	467	445	423	401	375	352	329	282	245
16 × 6	62	407	394	369	346	326	301	277	255	230	211	182	155
15 × 6	59	395	377	358	333	316	292	266	246	226	208	177	152
14 × 6	57	374	356	341	321	300	283	258	237	225	204	174	150
14 × 6	46	308	293	278	259	241	224	206	189	171	153	135	115
12 × 6	54	367	350	337	321	302	283	262	242	222	206	171	153
12 × 6	44	298	286	274	260	245	230	214	196	182	169	143	124
12 × 5	32	200	188	174	160	144	131	111	107	99	89	74	63
12 × 5	39	232	226	209	189	171	155	139	127	115	105	88	73
10 × 6	45	304	292	279	267	251	236	218	201	185	172	147	127
10 × 5	35	218	203	190	172	156	143	127	115	105	95	81	68
10 × 5	29	184	173	162	149	136	124	113	100	90	85	70	60
9 × 7	58	409	397	383	370	356	338	320	304	283	266	232	201
8 × 6	35	239	228	218	208	196	183	170	156	145	135	114	99
8 × 4	19	104	93	82	72	65	58	50	45	40	35	29	23
7 × 3¾	16	83	73	63	55	49	44	39	35	31	27	22	18
6 × 5	25	160	151	142	133	124	112	102	93	85	78	66	58
6 × 3	13	53	44	37	32	28	24	21	18	16	14	11	9
5 × 5	24	159	150	143	133	124	115	105	96	88	80	70	59
5 × 3	11	51	43	37	32	28	24	21	19	17	15	12	9
4 × 3	9½	43	37	31	27	23	20	18	16	14	12	10	8
3 × 3	10	48	42	36	31	27	24	21	18	16	14	12	9

DORMAN, LONG & COMPANY, LIMITED, MIDDLESBOROUGH.

PLATE GIRDERS.

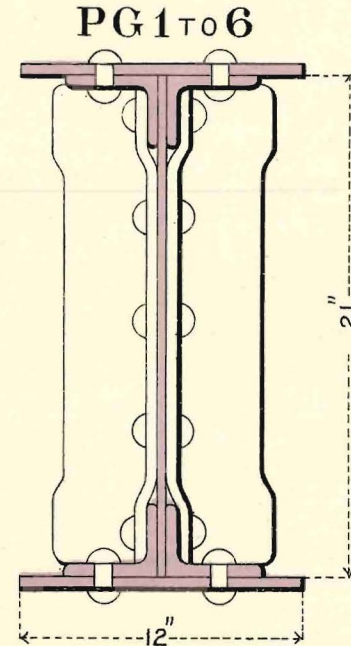

Table of Safe loads in Tons, for varying Spans.

SPAN IN FEET	NUMBER OF SECTION					
	PG 1	PG 2	PG 3	PG 4	PG 5	PG 6
20	57					
24	47	54				
28	40	46	52			
32	35	40	45	51		
36	31	36	40	45	49	
40		32	36	40	44	48
44			33	37	40	44
48				34	37	40
52					34	37
56						34
DEPTH IN INCHES	21	24	27	30	33	36

DORMAN, LONG & COMPANY, LIMITED, MIDDLESBOROUGH.

PLATE GIRDERS.

PG 7 TO 12

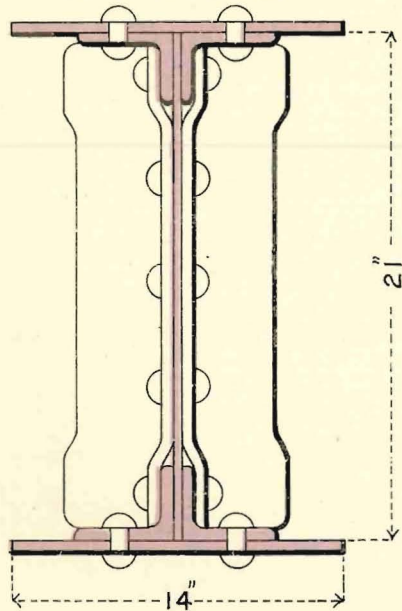

*Table of Safe loads in
Tons. for varying Spans.*

SPAN IN FEET	NUMBER OF SECTION					
	PG 7	PG 8	PG 9	PG 10	PG 11	PG 12
20	61					
24	51	58				
28	43	50	56			
32	38	43	49	54		
36	34	38	43	48	53	
40		35	39	43	48	52
44			35	39	43	47
48				36	40	43
52					37	40
56						37
DEPTH IN INCHES	21	24	27	30	33	36

DORMAN, LONG & COMPANY, LIMITED, MIDDLESBOROUGH.

PLATE GIRDERS.

PG 13 TO 18

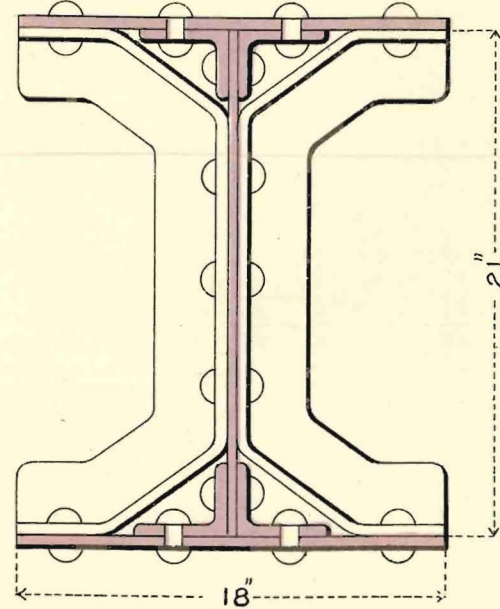

*Table of Safe loads in
Tons. for varying Spans.*

SPAN IN FEET	NUMBER OF SECTION					
	PG 13	PG 14	PG 15	PG 16	PG 17	PG 18
20	71					
24	59	67				
28	50	58	65			
32	44	50	57	63		
36	39	45	50	56	62	
40		40	45	50	55	61
44			41	46	50	55
48				42	46	50
52					43	46
56						43
DEPTH IN INCHES	21	24	27	30	33	36

DORMAN, LONG & COMPANY, LIMITED, MIDDLESBOROUGH.

PLATE GIRDERS.

PG 19 TO 24

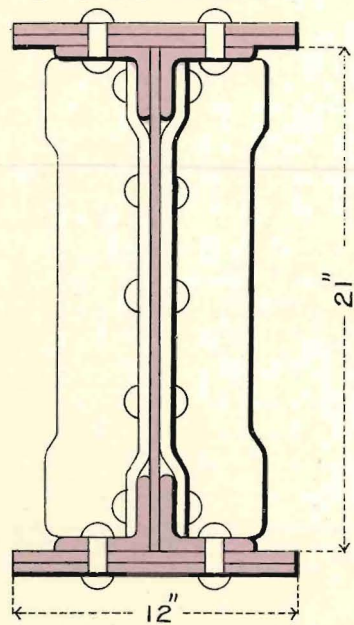

Table of Safe loads in Tons, for varying Spans.

SPAN IN FEET	NUMBER OF SECTION					
	PG 19	PG 20	PG 21	PG 22	PG 23	PG 24
20	84					
24	70	80				
28	60	68	77			
32	52	60	67	75		
36	46	53	60	66	73	
40		48	54	60	66	72
44			49	54	60	65
48				50	55	60
52					50	55
56						51
DEPTH IN INCHES	21	24	27	30	33	36

DORMAN, LONG & COMPANY, LIMITED, MIDDLESBOROUGH.

PLATE GIRDERS.

PG 25 TO 30

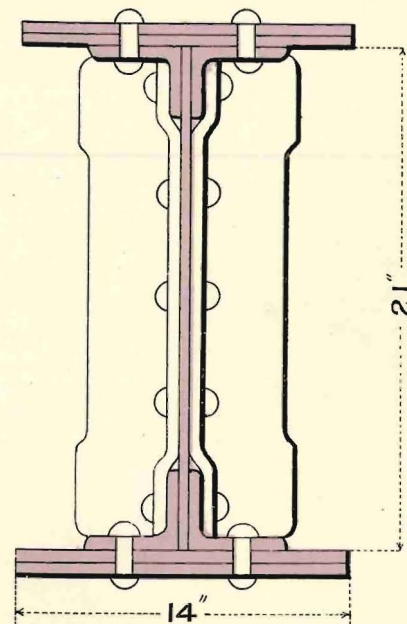

Table of Safe loads in Tons, for varying Spans.

SPAN IN FEET	NUMBER OF SECTION					
	PG 25	PG 26	PG 27	PG 28	PG 29	PG 30
20	92					
24	77	88				
28	66	75	85			
32	58	66	74	82		
36	51	58	66	73	81	
40		53	59	66	73	79
44			54	60	66	72
48				55	60	66
52					56	61
56						56
DEPTH IN INCHES	21	24	27	30	33	36

DORMAN, LONG & COMPANY, LIMITED, MIDDLESBOROUGH.

PLATE GIRDERS.

PG 31 TO 36

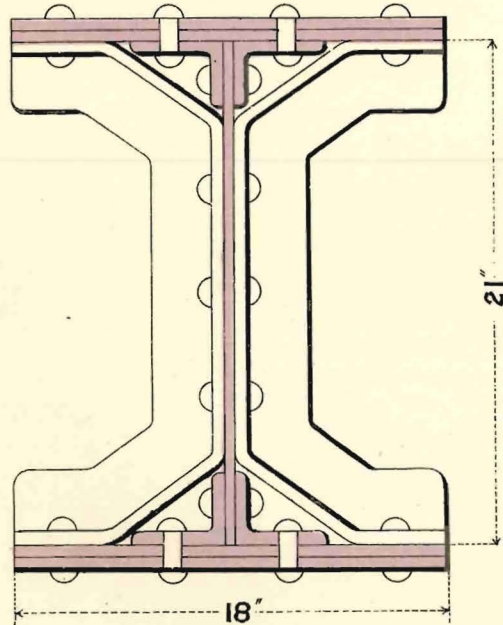

Table of Safe loads in Tons, for varying Spans.

SPAN IN FEET	NUMBER OF SECTION					
	PG 31	PG 32	PG 33	PG 34	PG 35	PG 36
20	112					
24	93	107				
28	80	91	103			
32	70	80	90	100		
36	62	71	80	89	98	
40		64	72	80	88	96
44			65	73	80	87
48				67	73	80
52					68	74
56						68
DEPTH IN INCHES	21	24	27	30	33	36

DORMAN, LONG & COMPANY, LIMITED, MIDDLESBOROUGH.

PLATE GIRDERS.

PG 37 TO 42

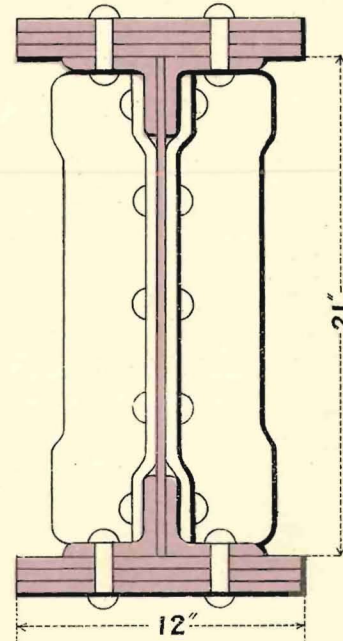

Table of Safe loads in Tons, for varying Spans.

SPAN IN FEET	NUMBER OF SECTION					
	PG 37	PG 38	PG 39	PG 40	PG 41	PG 42
20	111					
24	93	106				
28	79	91	102			
32	69	79	89	99		
36	62	70	79	88	97	
40		63	71	79	87	95
44			65	72	79	86
48				66	73	79
52					67	73
56						68
DEPTH IN INCHES	21	24	27	30	33	36

DORMAN, LONG & COMPANY, LIMITED, MIDDLESBOROUGH.

PLATE GIRDERS.

PG 43 TO 48

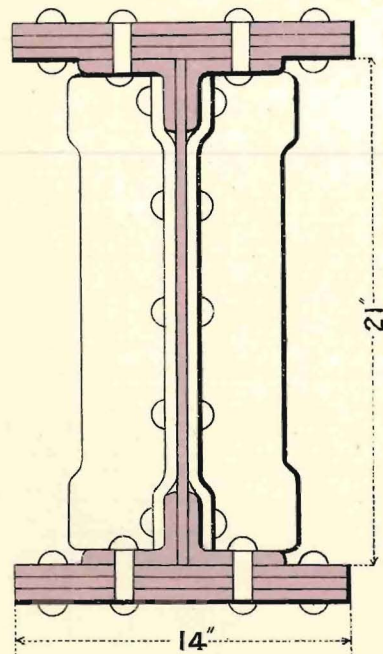

Table of Safe loads in Tons, for varying Spans.

SPAN IN FEET	NUMBER OF SECTION					
	PG 43	PG 44	PG 45	PG 46	PG 47	PG 48
20	124					
24	103	118				
28	88	101	114			
32	77	88	99	111		
36	69	78	88	98	108	
40		71	79	88	97	106
44			72	80	88	96
48				74	81	88
52					75	82
56						76
DEPTH IN INCHES	21	24	27	30	33	36

DORMAN, LONG & COMPANY, LIMITED, MIDDLESBOROUGH.

PLATE GIRDERS.

PG 49 TO 54

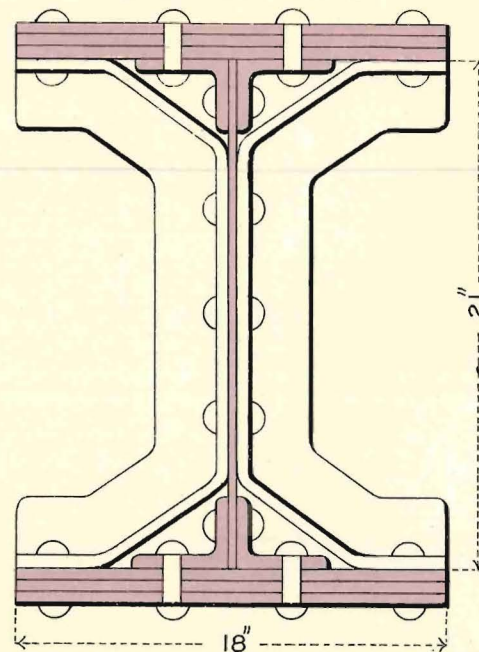

Table of Safe loads in Tons, for varying Spans.

SPAN IN FEET	NUMBER OF SECTION					
	PG 49	PG 50	PG 51	PG 52	PG 53	PG 54
20	153					
24	128	146				
28	109	125	141			
32	96	109	123	137		
36	85	97	109	122	134	
40		87	98	109	120	131
44			89	99	109	119
48				91	100	109
52					93	101
56						94
DEPTH IN INCHES	21	24	27	30	33	36

DORMAN, LONG & COMPANY, LIMITED, MIDDLESBOROUGH.

BOX GIRDERS.

BG 1 TO 6

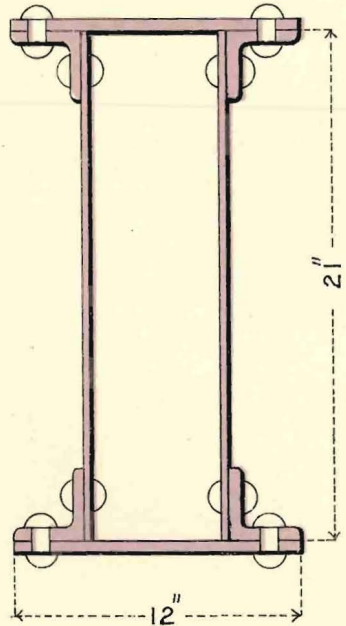

Table of Safe loads in Tons, for varying Spans.

SPAN IN FEET	NUMBER OF SECTION					
	BG 1	BG 2	BG 3	BG 4	BG 5	BG 6
20.	51					
24	43	49				
28	37	42	47			
32	32	37	41	46		
36	28	32	37	41	45	
40		29	33	37	40	44
44			30	33	37	40
48				30	33	37
52					31	34
56						31
DEPTH IN INCHES	21	24	27	30	33	36

DORMAN, LONG & COMPANY, LIMITED, MIDDLESBOROUGH.

BOX GIRDERS.

BG 7 TO 12

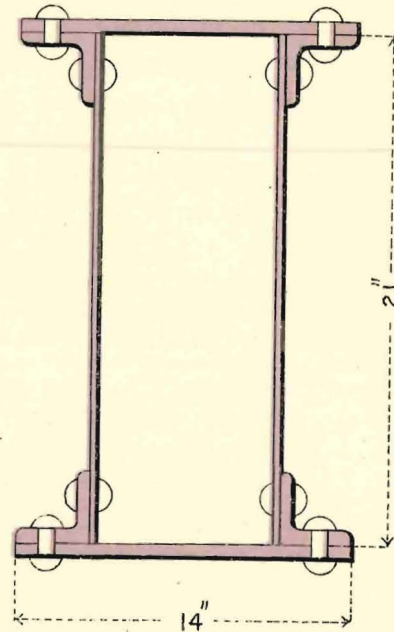

Table of Safe loads in Tons, for varying Spans.

SPAN IN FEET	NUMBER OF SECTION					
	BG 7	BG 8	BG 9	BG 10	BG 11	BG 12
20	57					
24	47	54				
28	40	46	52			
32	35	40	45	50		
36	31	36	40	45	49	
40		32	36	40	44	48
44			33	37	40	44
48				33	37	40
52					34	37
56						34
DEPTH IN INCHES	21	24	27	30	33	36

DORMAN, LONG & COMPANY, LIMITED, MIDDLESBOROUGH.

BOX GIRDERS.

BG13 TO 18

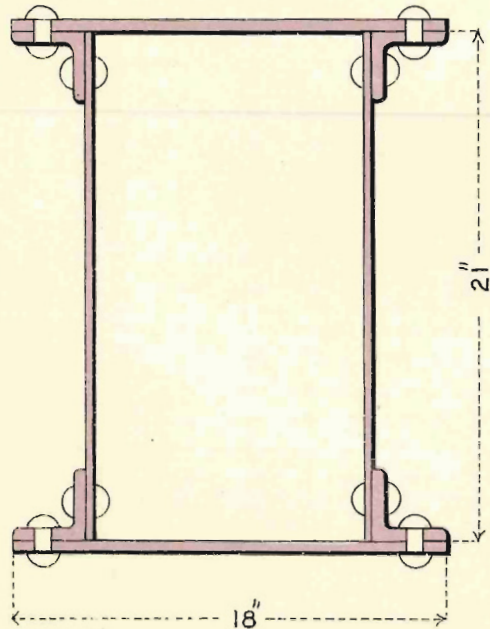

Table of Safe loads in Tons, for varying Spans.

SPAN IN FEET	NUMBER OF SECTION					
	BG 13	BG 14	BG 15	BG 16	BG 17	BG 18
20	72					
24	60	69				
28	52	59	66			
32	45	52	58	65		
36	40	46	52	57	63	
40		41	46	52	57	62
44			42	47	52	56
48				43	47	52
52					44	48
56						44
DEPTH IN INCHES	21	24	27	30	33	36

DORMAN, LONG & COMPANY, LIMITED, MIDDLESBOROUGH.

BOX GIRDERS.

BG 19 TO 24

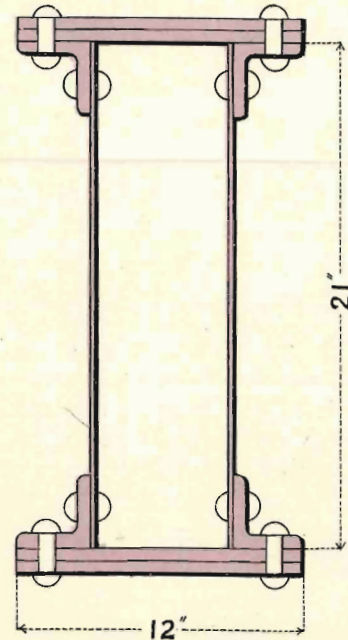

Table of Safe loads in Tons, for varying Spans.

SPAN IN FEET	NUMBER OF SECTION					
	BG 19	BG 20	BG 21	BG 22	BG 23	BG 24
20	79					
24	65	75				
28	56	64	72			
32	49	56	63	70		
36	43	50	56	62	69	
40		45	50	56	62	67
44			46	51	56	61
48				47	51	56
52					47	52
56						48
DEPTH IN INCHES	21	24	27	30	33	36

DORMAN, LONG & COMPANY, LIMITED, MIDDLESBOROUGH.

BOX GIRDERS.

BG 25 TO 30

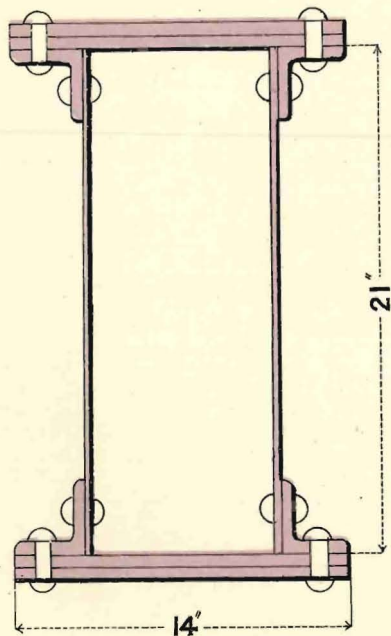

Table of Safe loads in Tons, for varying Spans.

SPAN IN FEET	NUMBER OF SECTION					
	BG 25	BG 26	BG 27	BG 28	BG 29	BG 30
20	89					
24	74	85				
28	63	73	82			
32	55	63	71	79		
36	49	56	63	71	78	
40		51	57	63	70	76
44			52	58	63	69
48				53	58	63
52					54	59
56						54
DEPTH IN INCHES	21	24	27	30	33	36

DORMAN, LONG & COMPANY, LIMITED, MIDDLESBOROUGH.

BOX GIRDERS.

BG 31 TO 36

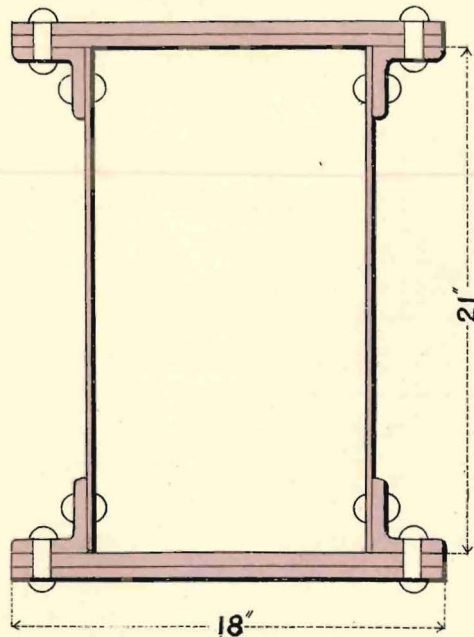

Table of Safe loads in Tons, for varying Spans.

SPAN IN FEET	NUMBER OF SECTION					
	BG 31	BG 32	BG 33	BG 34	BG 35	BG 36
20	115					
24	96	110				
28	82	94	106			
32	72	82	93	103		
36	64	73	82	91	101	
40		66	74	82	90	99
44			67	75	82	90
48				68	75	82
52					69	76
56						70
DEPTH IN INCHES	21	24	27	30	33	36

DORMAN, LONG & COMPANY, LIMITED, MIDDLESBOROUGH.

BOX GIRDERS.

BG 37 TO 42.

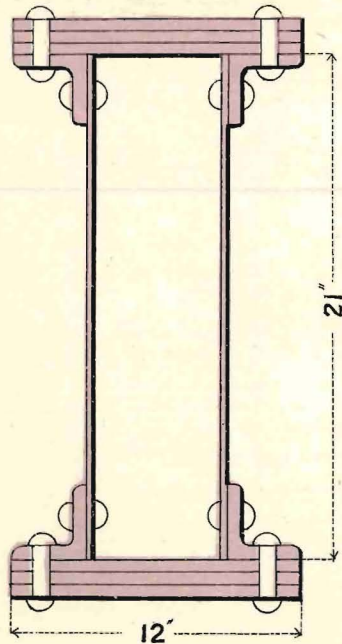

*Table of Safe loads in
Tons, for varying Spans.*

SPAN IN FEET	NUMBER OF SECTION					
	BG 37	BG 38	BG 39	BG 40	BG 41	BG 42
20	106					
24	88	101				
28	75	86	97			
32	66	75	85	94		
36	59	67	75	84	92	
40		60	67	75	83	91
44			62	69	75	82
48				63	69	75
52					64	70
56						65
DEPTH IN INCHES	21	24	27	30	33	36

DORMAN, LONG & COMPANY, LIMITED, MIDDLESBOROUGH.

BOX GIRDERS.

BG 43 TO 48

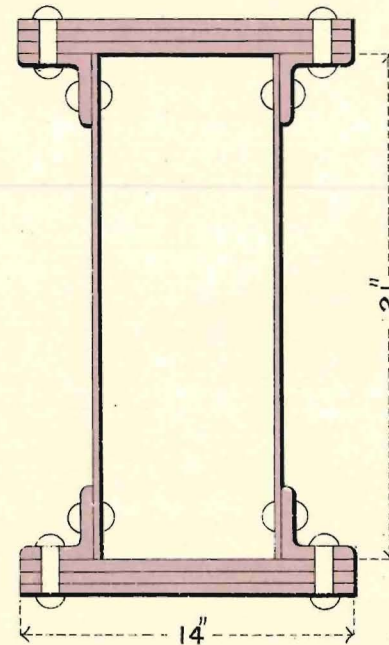

*Table of Safe loads in
Tons, for varying Spans.*

SPAN IN FEET	NUMBER OF SECTION					
	BG 43	BG 44	BG 45	BG 46	BG 47	BG 48
20	122					
24	100	116				
28	87	99	112			
32	76	87	98	108		
36	67	77	87	96	106	
40		69	78	87	95	104
44			71	79	87	95
48				72	79	87
52					73	80
56						74
DEPTH IN INCHES	21	24	27	30	33	36

DORMAN, LONG & COMPANY, LIMITED, MIDDLESBOROUGH.

BOX GIRDERS.

BG 49 TO 54

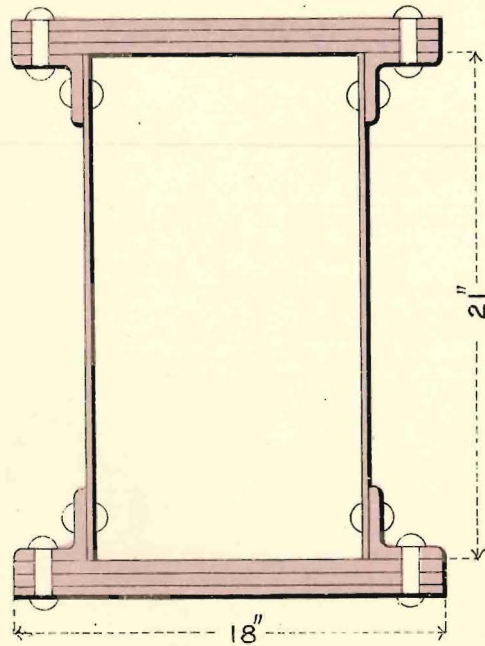

Table of Safe loads in Tons. for varying Spans.

SPAN IN FEET	NUMBER OF SECTION					
	BG 49	BG 50	BG 51	BG 52	BG 53	BG 54
20	158					
24	132	151				
28	113	129	145			
32	99	113	127	141		
36	88	100	113	126	138	
40		90	102	113	124	136
44			92	103	113	123
48				94	103	113
52					95	104
56						97
DEPTH IN INCHES	21	24	27	30	33	36

DORMAN, LONG, & CO., LIMITED.

THE Trough Decking illustrated by the accompanying plates has assumed a leading place among other methods of flooring bridges.

When fixed into position, it not only takes the place of cross girders, rail bearers, and timber planking, but in case of derailment forms a safer floor than the latter. Among other advantages, are the saving in cost and head room underneath, combined with absolute watertightness and ease of erection.

The results of careful calculations are given in tabulated form to each diagram, in order that users may at once determine the section required for carrying a certain weight safely. These calculations refer to exact width of section as dimensioned on each diagram. For example, Maximum Section C, page 168, is particularly adapted for public road bridges, where the span is from 16 to 20 ft.

The dead and live loads arising from weight of floor, metalling, and that of a traction engine equal a distributed load of 28 tons over an area of 20 ft. span and 8 ft. 4 in. in width (= 5 flutes). The moment of resistance of one flute = 198·90 ∴ 5 flutes = 994·50, which, divided by one-eighth of the span, = 30 in.; thus, $\frac{994 \cdot 50}{30} = 33 \cdot 15$ tons, which the floor will carry.

To carry Railway Traffic.—The application of Section Maximum C is illustrated on Plate 176, where the greatest loads in railway practice for a single line of way are collected to bear upon the flutes.

The calculations are based on an area for dead load of 15 ft. × 7 ft. = 5·72 tons,
 and 10 tons for each driving wheel = 20·00 "
 Total 25·72 "

Under these weights the calculations give a pressure of 5·66 tons on the square inch.

Attention is directed to Maximum Section E, which has been specially designed for supporting a double line of railway. See Plate No. 173 for enlarged section, which has a moment of resistance of 203·87 and 1,325·15 inch tons. See Plate No. 177, showing cross-section with loads imposed, viz.:-

Dead load over an area of 27 ft. 0 in. × 7 ft. 0 in.	=	14 tons.
Live load No. 4 driving wheels	40 "
Total	..	54 "

With the above loads, the strain on the metal is 5·22 tons on the square inch.

Plate No. 179 illustrates the application of Maximum Section E in the construction of a road bridge 36 ft. span and 18 ft. in width. This area, fully loaded by dead and live loads, aggregates 82 tons. The pressure per square inch is only 3·62 tons. The metal is strained to a greater extent by the passing over of a traction engine or road roller, where dead and live loads over two sections (6 ft. wide) equal 47 tons. These weights give a pressure of 6·22 tons per square inch.

The steel used is made on the "Siemens-Martin Open Hearth Acid Process," and is capable of standing the following tests:-

- 28 to 32 tons tensile strain.
- 20 per cent. elongation in a length of 8 inches.
- 40 per cent. contraction of area.

The smaller sections will be found especially useful for decking for piers, floors of warehouses, ceilings of subways, strong rooms, &c.

Any information as to appropriate sections for different cases of floors, together with estimate of cost, will be promptly given by Messrs. Dorman, Long, & Company, Limited, on application.

DORMAN, LONG & COMPANY, LIMITED, MIDDLESBOROUGH.

SECTION O MAXIMUM.

MOMENT OF RESISTANCE = 6·55. M.R. IN INCH TONS 42·57.

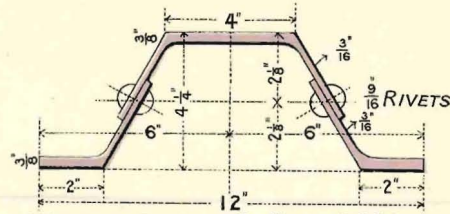

WEIGHT OF FLOOR PER SQ. FOOT = 19·06 LBS.

SECTION O MINIMUM.

MOMENT OF RESISTANCE = 4·92. M.R. IN INCH TONS = 32·00.

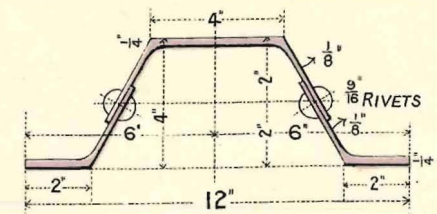

WEIGHT OF FLOOR PER SQ. FOOT = 13·40 LBS.

SECTIONS FOR GENERAL PURPOSES.

CLEAR SPAN IN FEET.	SQUARE FEET OF AREA COVERED.	SAFE DIST. LOADS IN TONS AT 6½ TONS PER SQ. FT.	SAFE LOAD PER SQUARE FOOT DIST. IN CWTs.	CLEAR SPAN IN FEET.	SQUARE FEET OF AREA COVERED.	SAFE DIST. LOADS IN TONS AT 6½ TONS PER SQ. FT.	SAFE LOAD PER SQUARE FOOT DIST. IN CWTs.
4	4	7·09	35·45	4	4	5·33	26·65
6	6	4·73	15·76	6	6	3·55	11·85
8	8	3·54	8·85	8	8	2·66	6·66
10	10	2·83	5·66	10	10	2·13	4·26
12	12	2·36	3·93	12	12	1·77	2·96
14	14	2·03	2·90	14	14	1·52	2·17
16	16	1·77	2·21	16	16	1·33	1·66
18	18	1·57	1·74	18	18	1·18	1·32

DORMAN, LONG & COMPANY, LIMITED, MIDDLESBOROUGH.

SECTION A MAXIMUM

MOMENT OF RESISTANCE = 11.05 M.R. IN INCH TONS = 71.82.

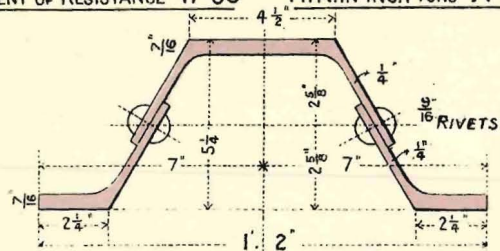

WEIGHT OF FLOOR PER SQ. FOOT = 23.10 LBS.

SECTION A MINIMUM

MOMENT OF RESISTANCE = 8.40 M.R. IN INCH TONS = 54.60.

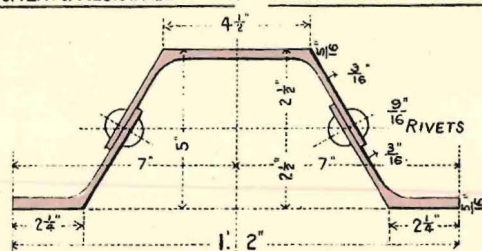

WEIGHT OF FLOOR PER SQ. FOOT = 17.61 LBS.

SECTIONS FOR GENERAL PURPOSES.

CLEAR SPAN IN FEET.	SQUARE FEET OF AREA COVERED.	SAFE DIST. LOADS IN TONS AT 6 1/2 TONS PER SQ. FT.	SAFE LOAD PER SQUARE FOOT DIST. IN CWTs.	CLEAR SPAN IN FEET.	SQUARE FEET OF AREA COVERED.	SAFE DIST. LOADS IN TONS AT 6 1/2 TONS PER SQ. FT.	SAFE LOAD PER SQUARE FOOT DIST. IN CWTs.
4	4.66	11.97	51.37	4	4.66	9.10	39.00
6	7.00	7.98	22.80	6	7.00	6.07	17.34
8	9.33	5.98	12.81	8	9.33	4.55	9.76
10	11.66	4.78	8.20	10	11.66	3.64	6.24
12	14.00	4.00	5.71	12	14.00	3.03	4.32
14	16.33	3.42	4.18	14	16.33	2.60	3.18
16	18.66	3.00	3.21	16	18.66	2.27	2.43
18	21.00	2.66	2.53	18	21.00	2.02	1.92

DORMAN, LONG & COMPANY, LIMITED, MIDDLESBOROUGH.

SECTION B MAXIMUM

MOMENT OF RESISTANCE = 17.50 M.R. IN INCH TONS = 113.75

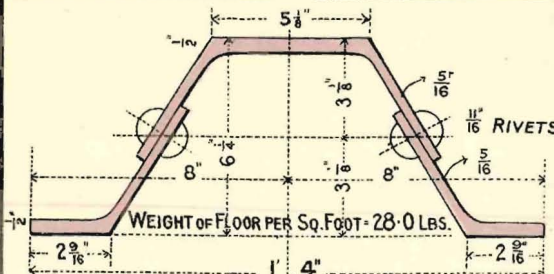

WEIGHT OF FLOOR PER SQ. FOOT = 28.0 LBS.

SECTION B MINIMUM

MOMENT OF RESISTANCE = 13.50 M.R. IN INCH TONS = 87.75

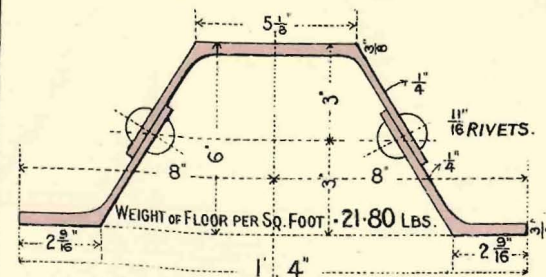

WEIGHT OF FLOOR PER SQ. FOOT = 21.80 LBS.

SECTIONS FOR GENERAL PURPOSES.

CLEAR SPAN IN FEET.	SQUARE FEET OF AREA COVERED.	SAFE DIST. LOADS IN TONS AT 6 1/2 TONS PER SQ. FT.	SAFE LOAD PER SQUARE FOOT DIST. IN CWTs.	CLEAR SPAN IN FEET.	SQUARE FEET OF AREA COVERED.	SAFE DIST. LOADS IN TONS AT 6 1/2 TONS PER SQ. FT.	SAFE LOAD PER SQUARE FOOT DIST. IN CWTs.
6	8.00	12.64	31.60	6	8.00	9.75	24.37
8	10.66	9.48	17.78	8	10.66	7.31	13.71
10	13.33	7.58	11.37	10	13.33	5.85	8.77
12	16.00	6.32	7.90	12	16.00	4.87	6.09
14	18.66	5.41	5.80	14	18.66	4.17	4.47
16	21.33	4.74	4.44	16	21.33	3.65	3.42
18	24.00	4.21	3.51	18	24.00	3.25	2.70
20	26.66	3.79	2.84	20	26.66	2.92	2.19
22	29.33	3.44	2.35	22	29.33	2.66	1.81
24	32.00	3.16	1.97	24	32.00	2.43	1.52

DORMAN, LONG & COMPANY, LIMITED, MIDDLESBOROUGH.

SECTION C MAXIMUM

M.R. IN INCH TONS = 198.90

MOMENT OF RESISTANCE = 30.60

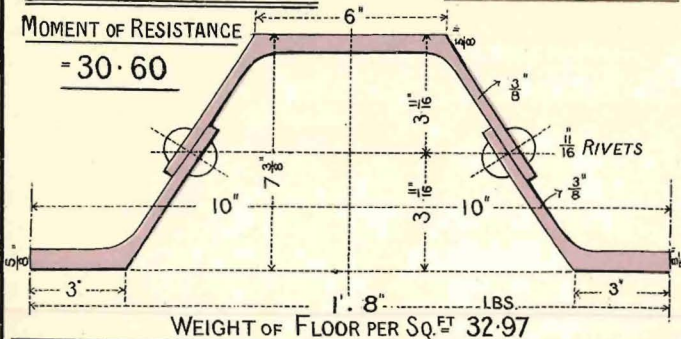

CLEAR SPAN IN FEET	SQUARE FEET OF AREA COVERED	SAFE DIST LOADS IN TONS AT 6 1/2 TONS PER SQ. FT.	SAFE LOAD PER SQUARE FOOT DIST IN CWTs.
8	13.33	16.57	24.85
10	16.66	13.26	15.91
12	20.00	11.05	11.05
14	23.33	9.47	8.11
16	26.66	8.29	6.21
18	30.00	7.36	4.91
20	33.33	6.63	4.97
22	36.66	6.03	3.29
24	40.00	5.52	2.76
26	43.33	5.10	2.35

SECTION C MINIMUM

M.R. IN INCH TONS = 140.53

MOMENT OF RESISTANCE = 21.62

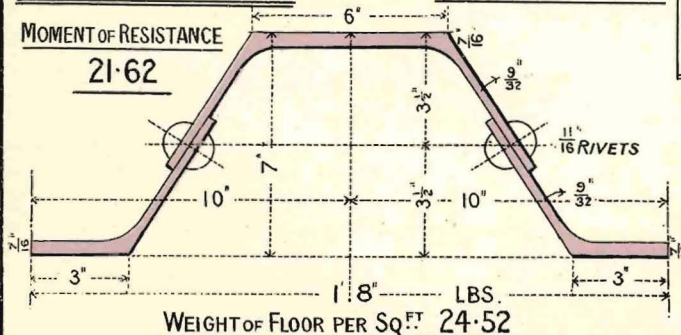

CLEAR SPAN IN FEET	SQUARE FEET OF AREA COVERED	SAFE DIST LOADS IN TONS AT 6 1/2 TONS PER SQ. FT.	SAFE LOAD PER SQUARE FOOT DIST IN CWTs.
8	13.33	11.71	17.56
10	16.66	9.37	11.24
12	20.00	7.81	7.81
14	23.33	6.69	5.73
16	26.66	5.85	4.39
18	30.00	5.20	3.47
20	33.33	4.68	2.81
22	36.66	4.25	2.32
24	40.00	3.90	1.59
26	43.33	3.60	1.67

BREAKING PRESSURE 28 TO 32 TONS PER SQUARE INCH.

WORKING PRESSURE 6 1/2 TONS AND UNDER PER SQUARE INCH.

SECTION C MAXIMUM IS ADAPTED IN STRENGTH FOR CARRYING SINGLE LINE OF RAILWAY.

SEE PLATE N° 176.

DORMAN, LONG & COMPANY, LIMITED, MIDDLESBOROUGH.

SECTION C' MAXIMUM

M.R. IN INCH TONS = 334.42

MOMENT OF RESISTANCE = 51.45

BREAKING PRESSURE 28 TO 32

TONS PER SQUARE INCH.

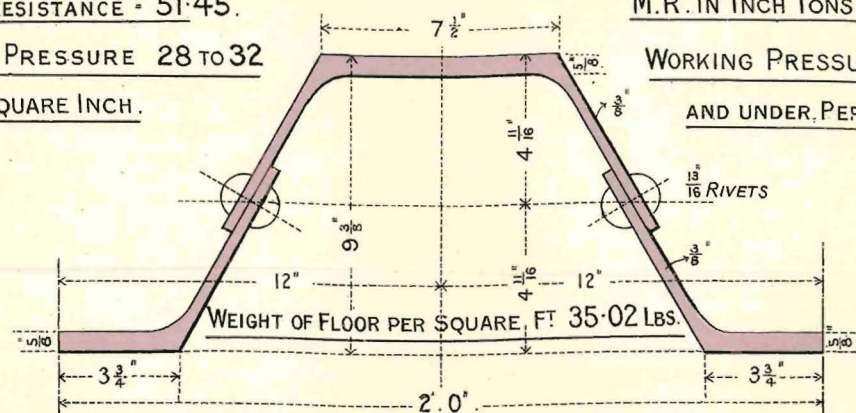

WORKING PRESSURE 6 1/2 TONS AND UNDER PER SQUARE INCH.

SECTION FOR CARRYING RAILWAY OVER SMALL SPANS. BOARD OF TRADE REQUIREMENTS.

CLEAR SPAN IN FEET.	SQUARE FEET OF AREA COVERED.	SAFE DIST LOADS IN TONS AT 6 1/2 TONS PER SQ. FT.	SAFE LOAD PER SQUARE FOOT DIST IN CWTs.	CLEAR SPAN IN FEET.	SQUARE FEET OF AREA COVERED.	SAFE DIST LOADS IN TONS AT 6 1/2 TONS PER SQ. FT.	SAFE LOAD PER SQUARE FOOT DIST IN CWTs.
10	20	22.30	22.30	22	44	10.13	4.60
12	24	18.58	15.65	24	48	9.29	3.87
14	28	15.92	11.37	26	52	8.57	3.30
16	32	13.93	8.70	28	56	7.96	2.84
18	36	12.39	6.88	30	60	7.43	2.47
20	40	11.15	5.57	32	64	6.96	2.17

DORMAN, LONG & COMPANY, LIMITED, MIDDLESBOROUGH.

SECTION C' MINIMUM

MOMENT OF RESISTANCE - 36.57

BREAKING PRESSURE 28 TO 32
TONS PER SQUARE INCH.

M.R. IN INCH TONS = 237.70.

WORKING PRESSURE 6½ TONS
AND UNDER PER SQUARE INCH.

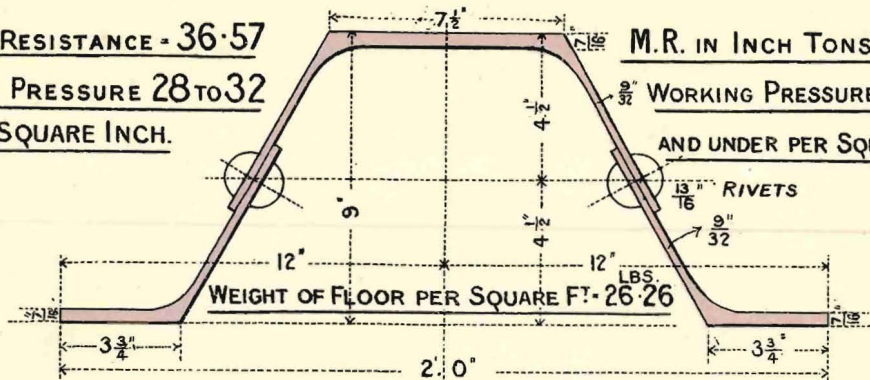

SECTION FOR GENERAL PURPOSES.

CLEAR SPAN IN FEET.	SQUARE FEET OF AREA COVERED.	SAFE DIST. LOADS IN TONS AT 6½ TONS PER SQ. FT.	SAFE LOAD PER SQUARE FOOT DIST. IN CWTs.	CLEAR SPAN IN FEET.	SQUARE FEET OF AREA COVERED.	SAFE DIST. LOADS IN TONS AT 6½ TONS PER SQ. FT.	SAFE LOAD PER SQUARE FOOT DIST. IN CWTs.
10	20	15.84	15.84	22	44	7.20	3.27
12	24	13.20	11.00	24	48	6.60	2.75
14	28	11.32	8.08	26	52	6.09	2.34
16	32	9.90	6.19	28	56	5.66	2.02
18	36	8.80	4.88	30	60	5.28	1.76
20	40	7.92	3.96	32	64	4.95	1.55

DORMAN, LONG & COMPANY, LIMITED, MIDDLESBOROUGH.

MOMENT OF RESISTANCE = 103.54.

BREAKING PRESSURE 28 TO 32
TONS PER SQUARE INCH.

M.R. IN INCH TONS = 673.0.

WORKING PRESSURE 6½ TONS
AND UNDER PER SQUARE INCH.

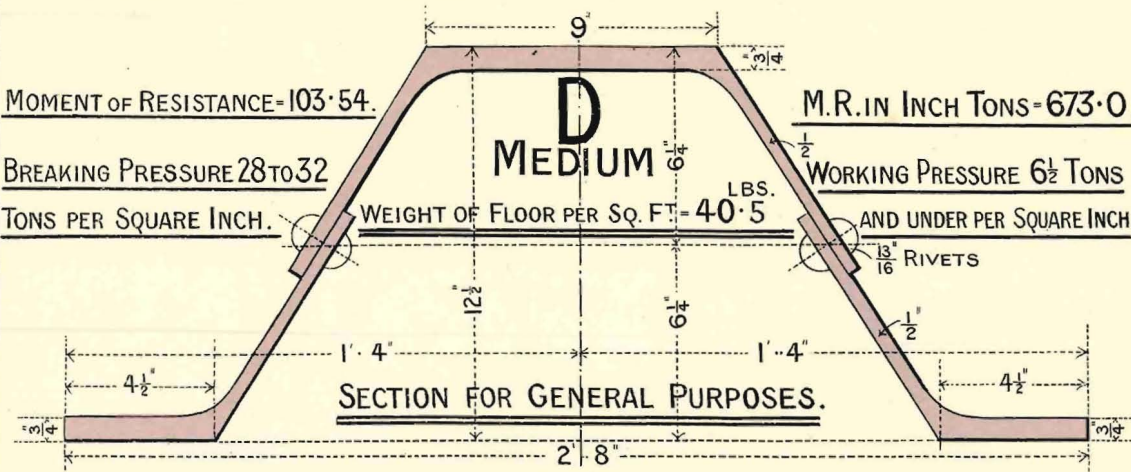

CLEAR SPAN IN FEET.	SQUARE FEET OF AREA COVERED.	SAFE DIST. LOADS IN TONS AT 6½ TONS PER SQ. FT.	SAFE LOAD PER SQUARE FOOT DIST. IN CWTs.	CLEAR SPAN IN FEET.	SQUARE FEET OF AREA COVERED.	SAFE DIST. LOADS IN TONS AT 6½ TONS PER SQ. FT.	SAFE LOAD PER SQUARE FOOT DIST. IN CWTs.
10	26.66	44.87	33.6	24	64.0	18.7	5.84
12	32.00	37.4	23.4	26	69.33	17.2	4.98
14	37.33	32.1	17.2	28	74.66	16.0	4.3
16	42.66	28.0	13.16	30	80.0	14.9	3.74
18	48.00	24.9	10.4	32	85.33	14.0	3.29
20	53.33	22.4	8.43	34	90.66	13.2	2.91
22	58.66	20.4	6.96	36	96.00	12.4	2.6

DORMAN, LONG & COMPANY, LIMITED, MIDDLESBOROUGH.

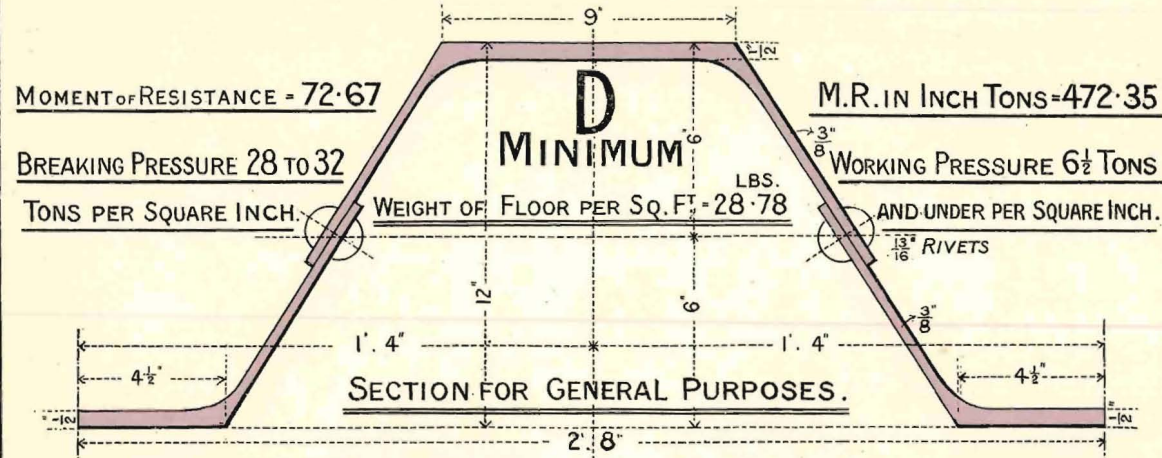

CLEAR SPAN IN FEET.	SQUARE FEET OF AREA COVERED.	SAFE DIST. LOADS IN TONS AT 6 1/2 TONS PER SQ. FT.	SAFE LOAD PER SQUARE FOOT DIST. IN CWTs.	CLEAR SPAN IN FEET.	SQUARE FEET OF AREA COVERED.	SAFE DIST. LOADS IN TONS AT 6 1/2 TONS PER SQ. FT.	SAFE LOAD PER SQUARE FOOT DIST. IN CWTs.
10	26.66	31.49	23.61	24	64.00	13.12	4.10.
12	32.00	26.24.	16.40	26	69.33	12.11	3.49.
14	37.33	22.49	12.05	28	74.66	11.24	3.01
16	42.66	19.68	9.22	30	80.00	10.49	2.62
18	48.00	17.49	7.28.	32	85.33	9.84	2.30
20	53.33	15.74	5.90	34	90.66	9.26	2.04
22	58.66	14.32	4.88	36	96.00	8.74	1.82

DORMAN, LONG & COMPANY, LIMITED, MIDDLESBOROUGH.

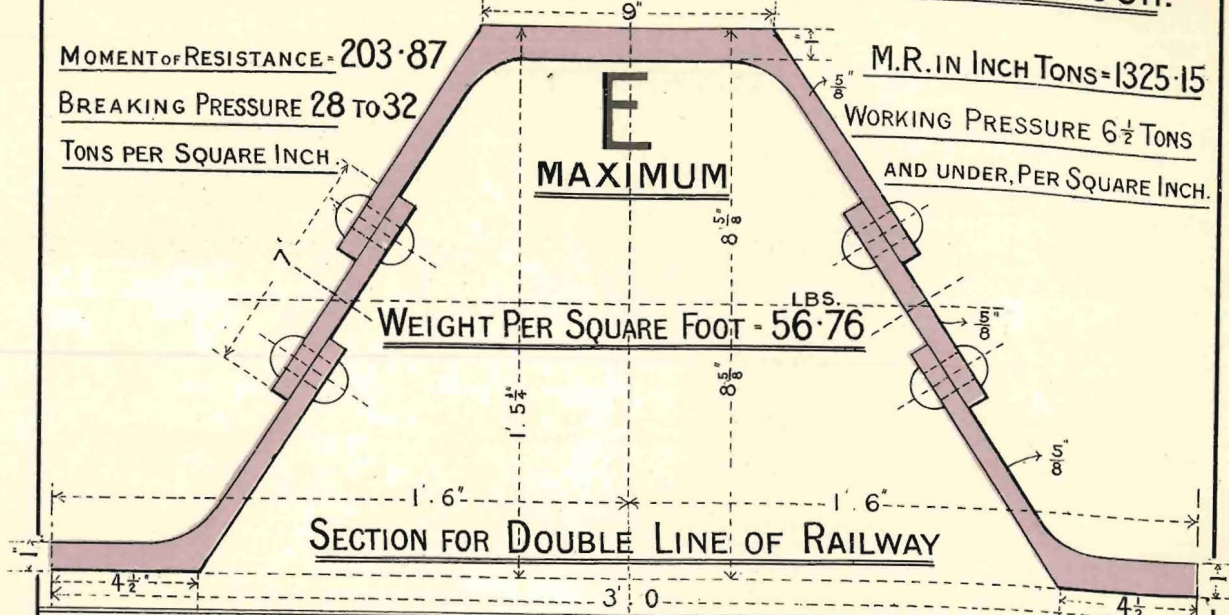

CLEAR SPAN IN FEET.	SQUARE FEET OF AREA COVERED.	SAFE DIST. LOADS IN TONS AT 6 1/2 TONS PER SQ. FT.	SAFE LOAD PER SQUARE FOOT DIST. IN CWTs.	CLEAR SPAN IN FEET.	SQUARE FEET OF AREA COVERED.	SAFE DIST. LOADS IN TONS AT 6 1/2 TONS PER SQ. FT.	SAFE LOAD PER SQUARE FOOT DIST. IN CWTs.
14	42	63.10	30.07	28	84	31.79	7.57
16	48	55.21	23.00	30	90	29.45	6.54
18	54	49.09	18.18	32	96	27.61	5.75
20	60	44.17	14.72	34	102	25.98	5.09
22	66	40.16	12.17	36	108	24.54	4.54
24	72	36.81	10.22	38	114	23.25	4.08
26	78	33.97	8.71	40	120	22.08	3.68

DORMAN, LONG & COMPANY, LIMITED, MIDDLESBOROUGH.

MOMENT OF RESISTANCE = 104.23

M.R. IN INCH TONS = 677.50

BREAKING PRESSURE 28 TO 32

WORKING PRESSURE 6½ TONS

TONS PER SQUARE INCH

AND UNDER PER SQUARE INCH.

E
MINIMUM

WEIGHT PER SQUARE FOOT = 32.18

LBS. 15 RIVETS 16

SECTION FOR GENERAL PURPOSES

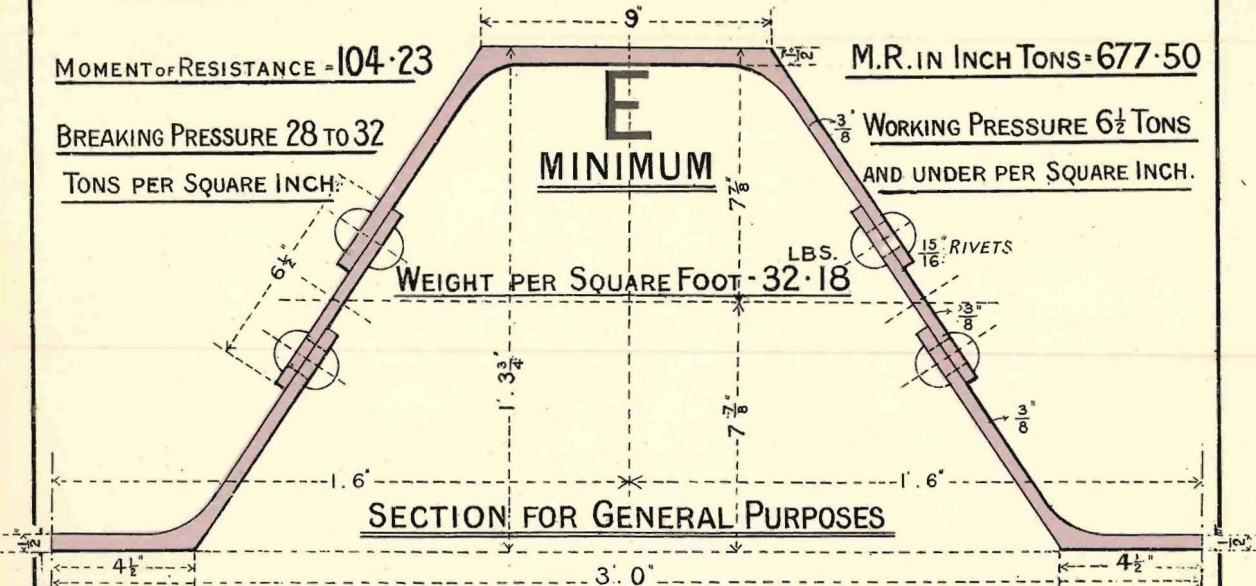

CLEAR SPAN IN FEET.	SQUARE FEET OF AREA COVERED.	SAFE DIST. LOADS IN TONS AT 6½ TONS PER SQ. FT.	SAFE LOAD PER SQUARE FOOT DIST. IN CWTs.	CLEAR SPAN IN FEET.	SQUARE FEET OF AREA COVERED.	SAFE DIST. LOADS IN TONS AT 6½ TONS PER SQ. FT.	SAFE LOAD PER SQUARE FOOT DIST. IN CWTs.
14	42	32.26	15.35	28	84	16.13	3.84
16	48	28.23	11.76	30	90	15.05	3.33
18	54	25.10	9.30	32	96	14.11	2.94
20	60	22.58	7.52	34	102	13.28	2.60
22	66	20.53	6.22	36	108	12.55	2.32
24	72	18.82	5.23	38	114	11.88	2.08
26	78	17.37	4.45	40	120	11.29	1.88

DORMAN, LONG & COMPANY, LIMITED, MIDDLESBOROUGH.

APPLICATION OF MAXIMUM SECTION A FOR DOUBLE LINE OF RAILWAY.

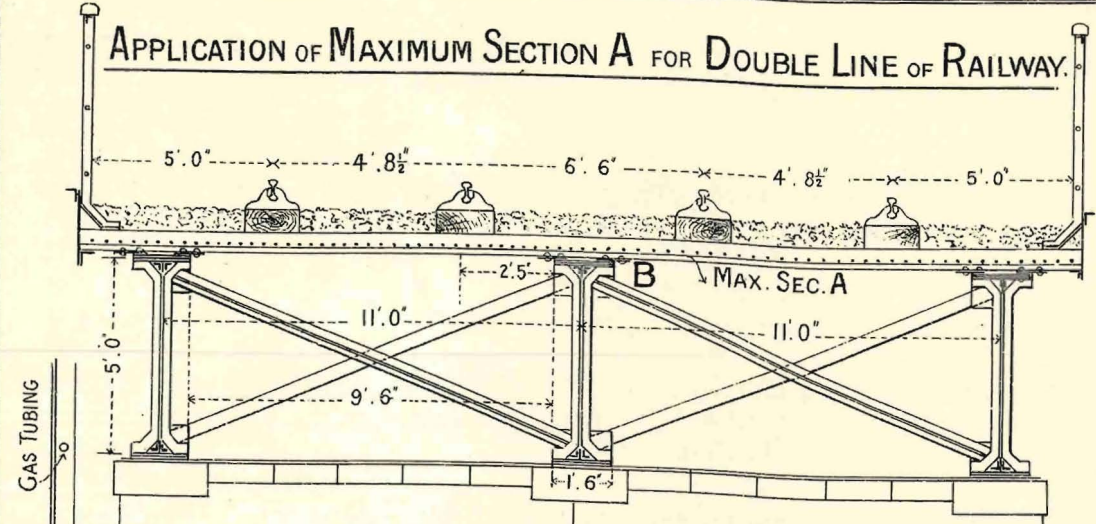

GAS TUBING

A IRON 3" x 3" x 1/2"

DETAIL AT A.

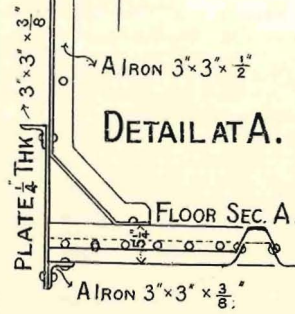

DETAIL AT B.

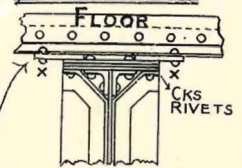

THESE PLATES ARE FIXED TO MAIN GIRDERS WITH CSK RIVETS, FLOOR LAID ON SMOOTH PLATE AND RIVETED IN POSITION WITH RIVETS X.X.

STRENGTH OF FLOOR AS SHOWN ABOVE, MAXIMUM SECTION A.

LIVE LOAD AT POINTS 7 FT APART = 10 TONS.
 DEAD LOAD AREA 9.6 x 7.0 = 66 SQ. FT. INCLUDING FLOOR ITSELF, BALLAST & PER. WAY - 1 CWT. PER SQ. FT. AND 1 CWT x 66 = 66 CWT. = 3.3 TONS

BENDING MOMENT, LIVE LOAD = 10 x 29 = 290
 " " DEAD LOAD = 3.3 x 9.5 x 12 = 47
 MOMENT OF RESISTANCE FOR 7 FT OF FLOOR = 337
 = 11.05 x 6 = 66.30
 B.M. = 337 / 66.30 = 5.08 TONS WORKING STRAIN PER SQ. INCH.
 M.R. = 66.30

DORMAN, LONG & COMPANY, LIMITED, MIDDLESBOROUGH.

SECTION A.B.

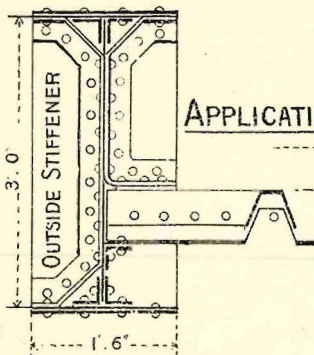

PART INSIDE ELEVATION OF MAIN GIRDER & CROSS SECTION OF FLOOR.

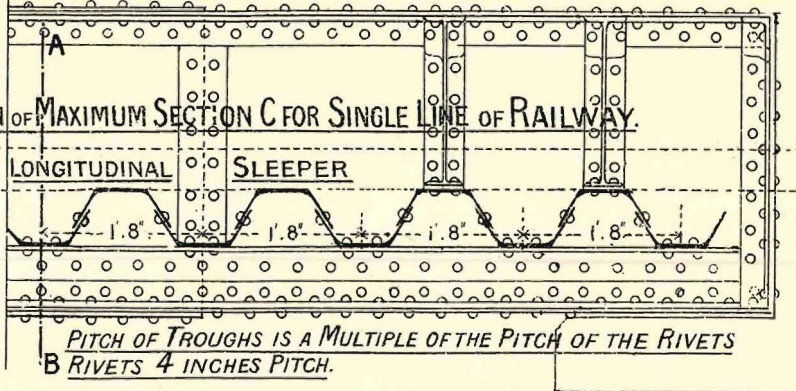

STRENGTH OF FLOOR MAXIMUM SECTION C WHERE CENTRES OF MAIN GIRDERS ARE 15 FEET APART.
 LIVE LOAD DRIVING WHEEL CARRIED ON LONGITUDINAL SLEEPER SPREAD OVER 7.0 OF FLUTES IN CROSS SECTION — PARALLEL WITH MAIN GIRDERS 10 TONS.
 DEAD LOAD AREA 15.0' x 7.0' = 105 SQUARE FEET, INCLUDING FLOOR ITSELF, BALLASTING AND PERMANENT WAY = 122 LBS. PER SQUARE FOOT, AND 105 SQ. FT. x 122 LBS. = 12810 LBS. 5.72 TONS.

BENDING MOMENT LIVE LOAD $10 \times 60^*$ (*FROM CENTRE OF MAIN GIRDER TO RAIL) 600
 " " DEAD LOAD $\frac{5.72 \times 15 \times 12}{8}$ 128
 MOMENT OF RESISTANCE OF 7 FT OF FLOOR - $30.60 \times 4.2 = 128.52$ 728
 B.M. = $\frac{728}{128.52} = 5.66$ TONS WORKING STRAIN PER SQUARE INCH IN STEEL.

DORMAN, LONG & COMPANY, LIMITED, MIDDLESBOROUGH.

APPLICATION OF MAXIMUM SECTION E FOR DOUBLE LINE OF RAILWAY.

DEAD LOAD IN CONCRETE, BALLAST, FLOOR & PER WAY, FOR AREA $27 \times 7'$ (WHEEL BASE) = 14 TONS.
 LIVE LOAD AT POINTS, DRIVING WHEELS OF LOCOMOTIVE 40 ..

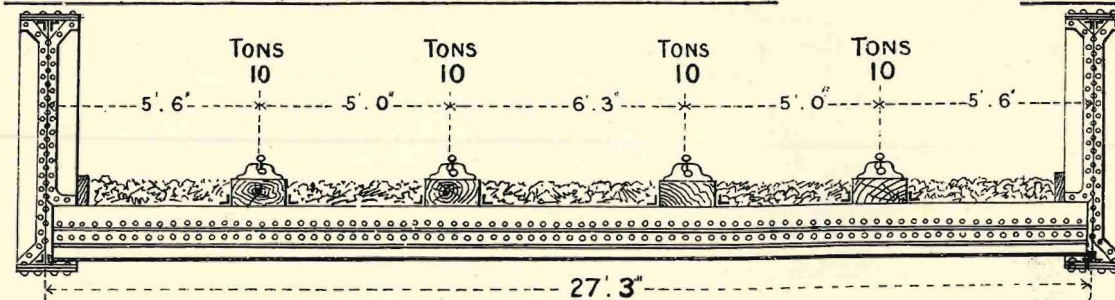

STRAINS FROM MAXIMUM WEIGHTS — RAILWAY TRAFFIC.

DEAD LOAD IN AREA OF $27 \times 7 = 189$ SQUARE FEET = TONS 14
 LIVE LOAD INCLUDES N°4 DRIVING WHEELS AT POINTS, EACH 10
 B.M. DEAD LOAD = $\frac{14 \times 27}{8} =$ FOOT TONS 47.25
 B.M. DUE TO 10 TONS DRIVERS AT POINTS = $10 (2 \times 5.6 + 5.0) =$ 160.00
 M.R. OF 7 FT OF FLOOR IN CROSS SECTION = 475.70 207.25
 B.M. = $\frac{2487.00}{475.70} = 5.22$ TONS PER SQ. INCH WORKING STRAIN. 2487.00 INCH TONS.
 M.R. = $\frac{2487.00}{475.70}$

DORMAN, LONG & COMPANY, LIMITED, MIDDLESBOROUGH.

MAXIMUM SECTION E CARRYING CROSS SLEEPER-ROAD IN TROUGHS OF FLOOR.

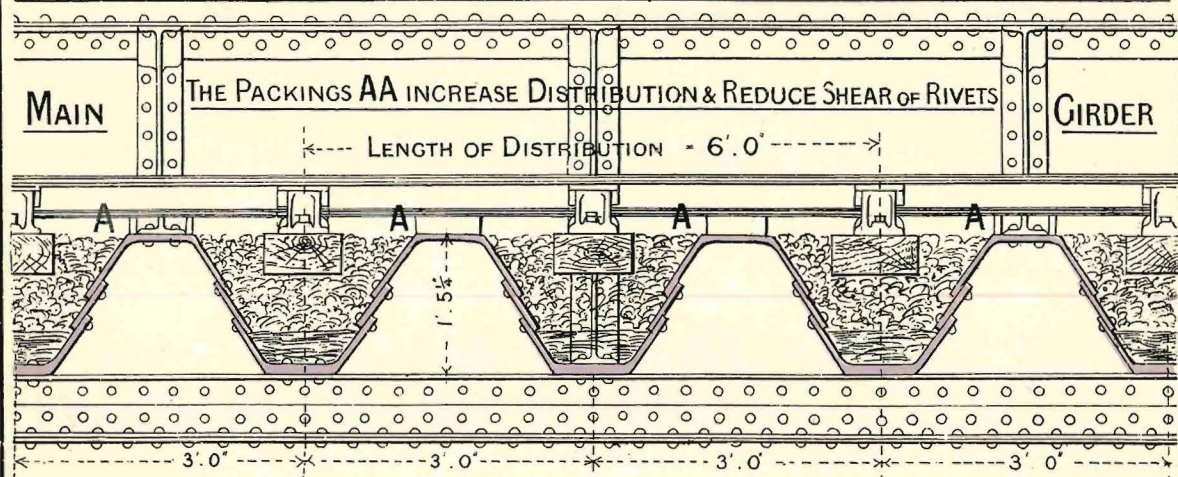

STRAINS FROM MAXIMUM WEIGHTS PRODUCED BY CROSS SLEEPER-ROAD

DISTRIBUTION ASSUMED AT 6.0' - TWO TROUGHS

DEAD LOAD IN CONCRETE, BALLAST, FLOOR & PER' WAY, AREA = 27' x 6' = 162 SQ. FEET.	TONS 11
LIVE LOAD INCLUDES N ^o 4 DRIVING WHEELS EACH 10 TONS AT POINTS SEE PLATE N ^o 13 (SPAN 27.0') - 40 TONS	
B.M. DUE TO DEAD LOAD = $\frac{11 \times 27}{8}$ =	37.125
B.M. DUE TO LIVE LOAD = $10(2 \times 5.6'' + 5.0'')$ =	160.000
M.R. OF 6.0' OF FLOOR IN CROSS SECTION - 407.74	197.125
B.M. = 2365.50	12
M.R. = 407.74 - 5.80 TONS PER SQ. INCH WORKING STRAIN	2365.500

SEE PLATE N^o 173.

DORMAN, LONG & COMPANY, LIMITED, MIDDLESBOROUGH.

SECTIONS C, C', D & E (MAX) APPLIED TO PUBLIC ROAD BRIDGES. SPANS FROM 12 TO 36 FEET.

EXAMPLE MAXIMUM SECTION E.

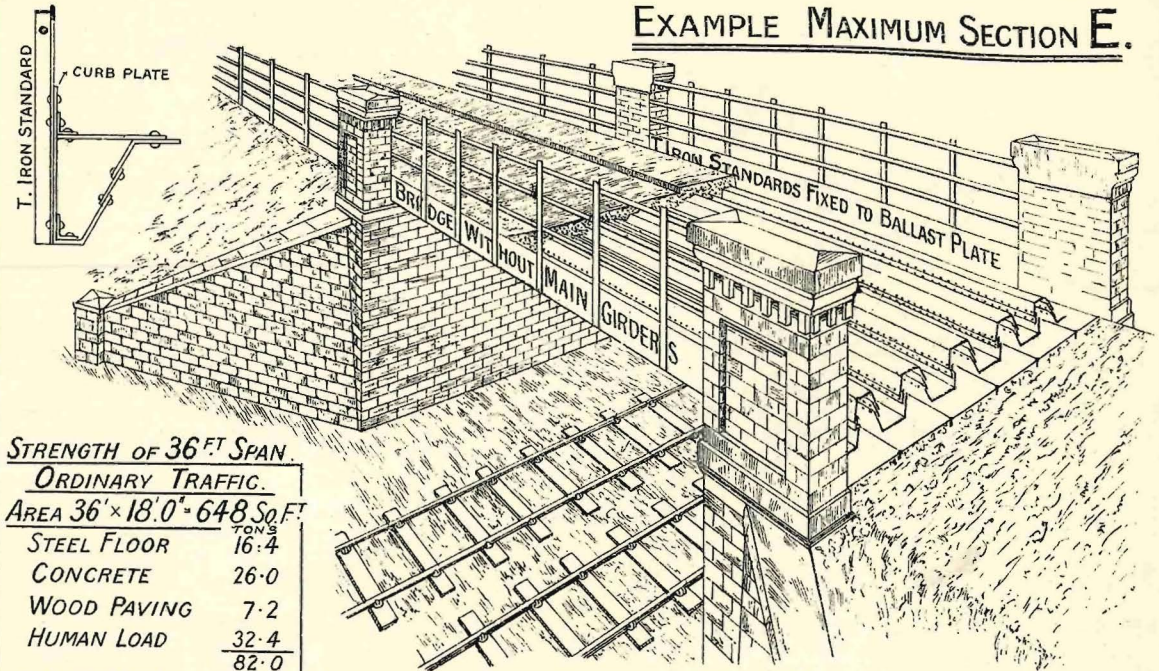

STRENGTH OF 36 FT SPAN

ORDINARY TRAFFIC.	
AREA 36' x 18.0' = 648 SQ. FT.	
STEEL FLOOR	16.4
CONCRETE	26.0
WOOD PAVING	7.2
HUMAN LOAD	32.4
	82.0

B.M. $\frac{82 \times 36 \times 12}{8}$ = 4428. M.R. OF 6 SECTIONS = 203.87 x 6 = 1223.22.	B.M. = $\frac{4428}{1223.22}$ = 3.62 TONS PRESSURE PER SQ.
ROAD ROLLER OR TRACTION ENGINE TRAFFIC.	
DEAD LOAD ON 2 SECTIONS = 17	} B.M. = $\frac{47 \times 36 \times 12}{8}$ = 2538
ROLLER 15, AT CENTRE DIST ^o = 30	
M.R. = 203.87 x 2 = 407.74	} B.M. = $\frac{2538}{407.74}$ = 6.22 TONS PER SQ. INCH.
	47 TONS.

SEE PLATE N^o 173.

DORMAN, LONG & COMPANY, LIMITED, MIDDLESBOROUGH.

MOMENT OF RESISTANCE OF 1' 8" A TO B = 18.81. MOMENT OF RESISTANCE INCH TONS = 122.26.

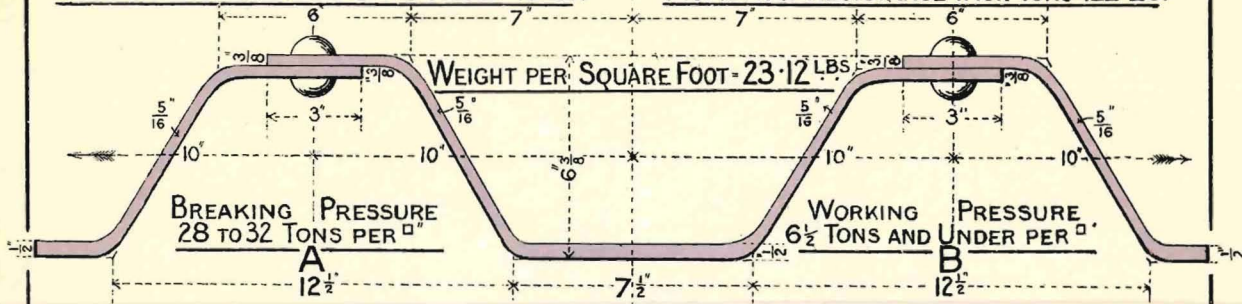

SECTION OF TROUGHING AS MADE FOR INDIAN STATE RAILWAYS.

CLEAR SPAN IN FEET.	SQUARE FEET OF AREA COVERED A TO B	SAFE DIST LOADS IN TONS AT 6 1/2 TONS PER SQ. FT.	SAFE LOAD PER SQUARE FOOT DIST IN CWTs.	CLEAR SPAN IN FEET.	SQUARE FEET OF AREA COVERED A TO B	SAFE DIST LOADS IN TONS AT 6 1/2 TONS PER SQ. FT.	SAFE LOAD PER SQUARE FOOT DIST IN CWTs.
6	10.00	13.59	27.18	16	26.66	5.09	3.82
7	11.66	11.64	19.95	17	28.33	4.79	3.38
8	13.33	10.18	15.27	18	30.00	4.52	3.01
9	15.00	9.05	12.06	19	31.66	4.29	2.71
10	16.66	8.15	9.78	20	33.33	4.07	2.44
11	18.33	7.41	8.00	21	35.00	3.88	2.21
12	20.00	6.79	6.79	22	36.66	3.71	2.02
13	21.66	6.27	5.78	23	38.33	3.54	1.84
14	23.33	5.82	5.00	24	40.00	3.39	1.69
15	25.00	5.43	4.34	25	41.66	3.26	1.55

DORMAN, LONG & COMPANY, LIMITED, MIDDLESBOROUGH.

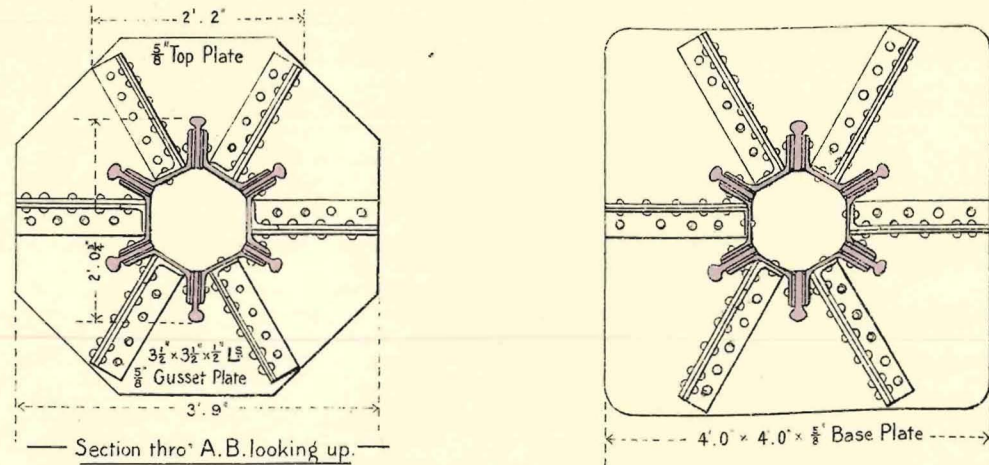

SINGLE COLUMN MADE FOR BRUNSWICK DOCK WAREHOUSES.

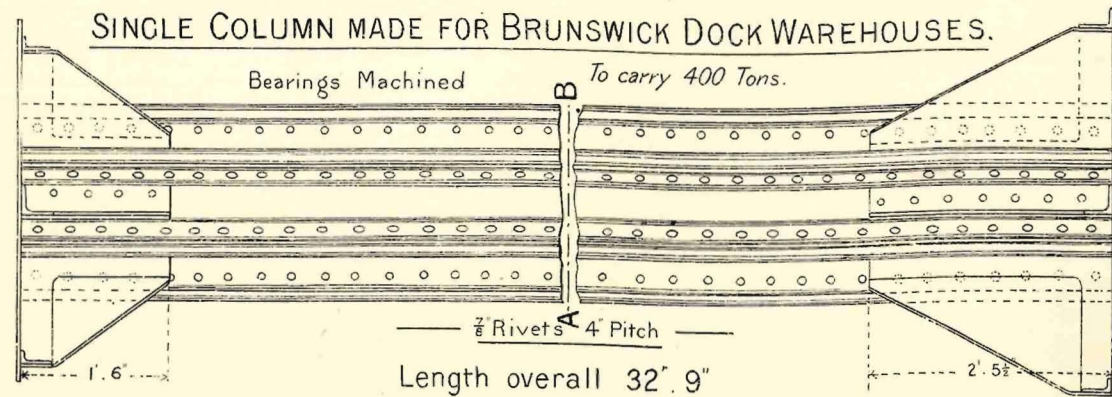

MEMORANDA. ∞